

CoreStation

설치 가이드

버전 1.05

한국어

KO 101.00.CS-40 V1.05A

목차

안전을 위한 주의사항	2	제품 사양	19
기호	2	제품 치수	20
시작하기	4	FCC 준수 정보	21
문서번호	4		
구성품	4	부록	22
액세서리	5	면책 조항	22
각 부분의 명칭 및 기능	6	저작권 공지	22
		오픈 소스 라이선스	22
설치	12	GNU General Public License	23
배터리	12	TERMS AND CONDITIONS	23
전원 연결	13	GNU Lesser General Public License	30
네트워크 연결	14	OpenSSL License	32
TCP/IP	14	Original SSLeay License	33
RS-485 연결	15		
릴레이 연결	16		
Fail Safe Lock	16		
Fail Secure Lock	16		
Wiegand 입력 연결	17		
출입문 센서 및 퇴실 버튼 연결	17		
AUX 입력 연결	18		

안전을 위한 주의사항

사용자의 위험이나 재산상의 손해를 막기 위해 제품을 사용하기 전에 이 설명서를 반드시 읽고 제품을 안전하고 올바르게 사용하십시오. 이 설명서에서 말하는 제품이란 본체와 함께 제공되는 모든 구성품을 포함합니다.

기호



경고: 제품을 사용할 때 위반할 경우 심각한 상해나 사망에 이를 수 있는 경고 사항을 표기할 때 사용합니다.



주의: 제품을 사용할 때 위반할 경우 경미한 상해나 제품 손상이 발생할 수 있는 주의 사항을 표기할 때 사용합니다.



알아두기: 제품을 사용할 때 참고 사항이나 추가 정보를 제공할 때 사용합니다.



경고

설치

사용자가 임의로 제품을 설치하거나 수리하지 마십시오.

- 화재, 감전, 부상의 원인이 됩니다.
- 사용자의 임의 설치나 수리로 인해 제품이 손상된 경우 무상 수리 서비스가 제공되지 않습니다.

제품을 직사광선에 노출된 장소, 습기, 먼지나 그을음이 많은 장소, 가스가 쉐 가능성이 있는 장소에 설치하지 마십시오.

- 화재 또는 감전의 원인이 됩니다.

제품을 전열기 등으로 인해 열이 발생하는 장소에 설치하지 마십시오.

- 과열로 인한 화재 또는 감전의 원인이 됩니다.

물기가 있는 곳에 설치하지 마십시오.

- 습기로 인한 감전 또는 제품 손상의 원인이 됩니다.

전자파 장애가 있는 곳에 설치하지 마십시오.

- 감전 또는 제품 손상의 원인이 됩니다.

사용

제품 내부에 물, 음료수, 약품 등의 액체가 들어가지 않도록 주의하십시오.

- 화재, 감전, 제품 손상의 원인이 됩니다.

손상된 전원 어댑터나 플러그, 헐거운 콘센트는 사용하지 마십시오.

- 접촉이 불안정할 경우 화재 또는 감전의 원인이 됩니다.

전원 코드를無理하게 구부리거나 망가뜨리지 마십시오.

- 화재 또는 감전의 원인이 됩니다.



주의

설치

제품을 직사광선이나 자외선에 직접 노출된 장소에 설치하지 마십시오.

- 제품 손상, 오작동 및 변색, 변형의 원인이 됩니다.

전원 케이블 등을 통행 장소에 방치하지 마십시오.

- 신체 상해 또는 제품 손상의 원인이 됩니다.

자석, TV, (CRT) 모니터, 스피커 등 자성이 강한 물체 주변에 설치하지 마십시오.

- 고장의 원인이 됩니다.

사용

제품을 떨어뜨리거나 충격을 주지 마십시오.

- 고장의 원인이 됩니다.

제품의 버튼(터치패드)을 무리하게 누르거나 날카로운 도구를 사용해 누르지 마십시오.

- 고장의 원인이 됩니다.

제품을 0°C ~50°C 이내에서 사용하고 너무 낮거나 높은 온도에서 보관하지 마십시오.

- 고장의 원인이 됩니다.

제품을 청소할 때 주의하십시오.

- 제품을 표면을 깨끗한 마른 천으로 부드럽게 닦으십시오.
- 제품을 소독해야 할 경우 마른 천에 소독용 알코올을 적당량 묻힌 뒤 제품 표면을 부드럽게 닦으십시오. 이소프로필 알코올이 70~75% 함유된 소독용 알코올과 깨끗하고 보풀이 없는 부드러운 천을 사용하십시오.
- 소독제를 제품에 직접 분사하지 마십시오.

제품을 원래 용도 이외 다른 용도로 사용하지 마십시오.

- 고장의 원인이 됩니다.

시작하기

문서번호

문서 번호	개정	제목 / 설명
EN 101.00.CS40	V1.04A	CoreStation Installation Guide
EN 102.00.CS40	V1.00A	CoreStation Setup Manager User Guide
201.00.CS40	V1.00A	CoreStation Intelligent Biometric Controller: Quick Guide
EN 102.00.BS2	V1.8.5A	BioStar 2.8.5 Administrator Guide
EN 101.00.BS2	V1.8.5A	BioStar 2.8.5 Installation Guide
EN 201.00.BS2	V1.01A	BioStar 2 Quick Guide
Warranty_SP_001	V12	Suprema Warranty Policy

구성품

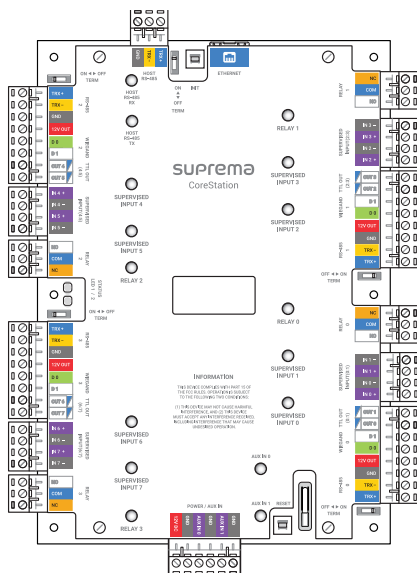

CoreStation

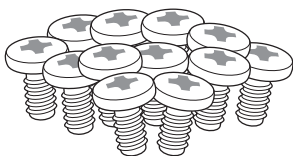

고정용 나사 x12

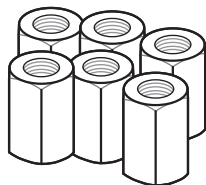

스페이서 x6

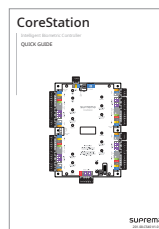

퀵 가이드

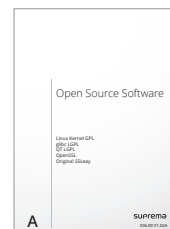

오픈소스라이선스 가이드



- 구성품은 설치 환경에 따라 달라질 수 있습니다.

액세서리

CoreStation은 액세서리로 함체를 함께 구매할 수 있습니다. 함체에는 LED 제어 보드, 전원 제어 보드, 전원 장치, 배터리, 탭퍼가 포함되어 있습니다.

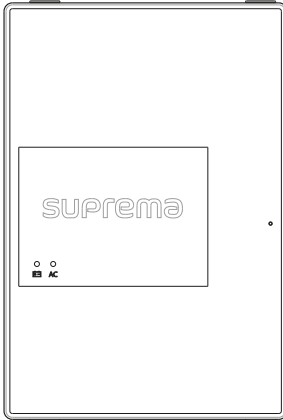

- ENCR-10은 벽에 고정하여 사용할 수 있도록 설계되었습니다. 설치 높이에 제한 없이 안전하고 사용하기에 편리한 위치에 설치하십시오.
- ENCR-10 구성품에는 함체 고정용 나사, CoreStation 고정용 나사, 전원 장치 연결용 나사가 포함되어 있습니다. 각 나사의 용도에 맞추어 올바르게 사용하십시오.
 - 함체 고정용 나사(직경: 4 mm, 길이: 25 mm) x 4
 - CoreStation 고정용 나사(직경: 3 mm, 길이: 5 mm) x 6
 - 전원 장치 케이블 고정용 나사(직경: 3 mm, 길이: 8 mm) x 1

각 부분의 명칭 및 기능

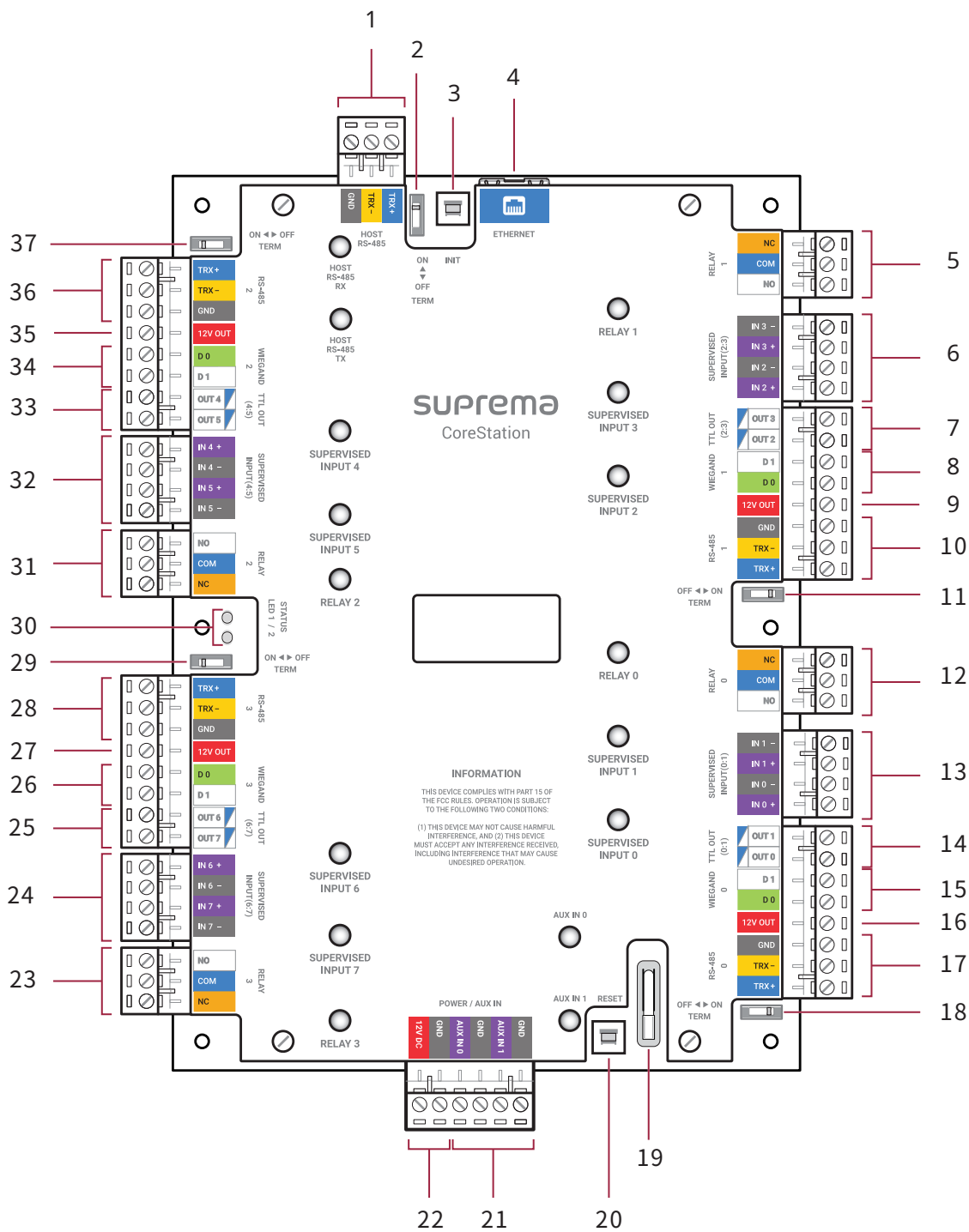

No.	이름	No.	이름
1	HOST RS-485 연결	20	RESET 버튼
2	HOST RS-485 종단 저항 스위치	21	AUX IN (0, 1) 연결
3	INIT 버튼	22	CoreStation 전원 연결(DC 12V IN)
4	이더넷 연결	23	릴레이 3 연결
5	릴레이 1 연결	24	TTL 입력 (6, 7) 또는 Supervised Input (6, 7) 연결
6	TTL 입력 (2, 3) 또는 Supervised Input (2, 3) 연결	25	TTL 출력 (6, 7) 연결
7	TTL 출력 (2, 3) 연결	26	Wiegand 3 연결
8	Wiegand 1 연결	27	12VDC 출력
9	12VDC 출력	28	RS-485 3 연결
10	RS-485 1 연결	29	RS-485 3 종단 저항 스위치
11	RS-485 1 종단 저항 스위치	30	CoreStation 상태 LED
12	릴레이 0 연결	31	릴레이 2 연결
13	TTL 입력 (0, 1) 또는 Supervised Input (0, 1) 연결	32	TTL 입력 (4, 5) 또는 Supervised Input (4, 5) 연결
14	TTL 출력 (0, 1) 연결	33	TTL 출력 (4, 5) 연결
15	Wiegand 0 연결	34	Wiegand 2 연결
16	12VDC 출력	35	12VDC 출력
17	RS-485 0 연결	36	RS-485 2 연결
18	RS-485 0 종단 저항 스위치	37	RS-485 2 종단 저항 스위치
19	RTC 배터리		



- 장치와 연동된 CoreStation을 초기화한 뒤 다른 장치에 연결하려면 INIT 버튼을 2초 이상 누르십시오.
- CoreStation과 Wiegand 장치를 연결할 때 Wiegand 장치의 전원으로 CoreStation의 전원 출력(12V, 최대 1.5A)을 사용할 수 있습니다. 200mA를 소모하는 Wiegand 장치를 3대 연결하면 남아 있는 전원 출력 단자에 최대 900mA를 소모하는 장치를 연결할 수 있습니다.
- RTC 배터리 용량은 226mah이며, 기대 수명은 설치 환경 및 동작 방법에 따라 다를 수 있습니다. RTC 배터리 교체 시에는 CR2032를 준수하십시오.

통신 상태 LED

LED	상태
HOST RS-485 TX	주황색 점멸: RS-485 데이터를 송신 중인 상태
HOST RS-485 RX	녹색 점멸: RS-485 데이터를 수신 중인 상태
RELAY (0 ~ 3)	빨간색 점등: 릴레이 동작
SUPERVISED INPUT (0 ~ 7)	TTL 입력을 사용할 때 <ul style="list-style-type: none"> • 녹색 점등: Normal Close • 꺼짐: Normal Open Supervised Input을 사용할 때 <ul style="list-style-type: none"> • 녹색 점등: Normal Close(합선), Normal Open, 스위치 켜짐 • 꺼짐: 스위치 꺼짐
AUX IN (0, 1)	주황색 점등: AUX 신호를 수신 중인 상태

출입통제 등급

기능	등급
Destructive Attack	I
Line Security	I
Endurance	IV
Standby Power	I
Single Point Locking Device with Key Locks	I

CoreStation 상태 LED

CoreStation의 상태는 제품 전면부의 왼쪽에 위치한 STATUS LED 1 / 2로 확인할 수 있으며, 이더넷, RS-485 0, RS-485 1, RS-485 2, RS-485 3, RS-485 HOST, 시스템의 상태를 1초씩 순서대로 보여줍니다.

항목	LED 1	LED 2	상태
이더넷	빨간색	빨간색	유동 IP 연결 실패
	빨간색	노란색	유동 IP 연결 대기 중
	빨간색	하늘색	고정 IP 연결 성공
	빨간색	파란색	유동 IP 연결 성공
	빨간색	자홍색	고정 IP 연결 실패
	빨간색	꺼짐	HW 오류
RS-485 0	노란색	빨간색	슬레이브 장치 없음
	노란색	노란색	슬레이브 장치 연결 해제
	노란색	파란색	슬레이브 장치 정상
	노란색	꺼짐	HW 오류
RS-485 1	녹색	빨간색	슬레이브 장치 없음
	녹색	노란색	슬레이브 장치 연결 해제
	녹색	파란색	슬레이브 장치 정상
	녹색	꺼짐	HW 오류
RS-485 2	하늘색	빨간색	슬레이브 장치 없음
	하늘색	노란색	슬레이브 장치 연결 해제
	하늘색	파란색	슬레이브 장치 정상
	하늘색	꺼짐	HW 오류
RS-485 3	파란색	빨간색	슬레이브 장치 없음
	파란색	노란색	슬레이브 장치 연결 해제
	파란색	파란색	슬레이브 장치 정상
	파란색	꺼짐	HW 오류
RS-485 HOST	자홍색	빨간색	슬레이브 장치 없음
	자홍색	노란색	슬레이브 장치 연결 해제
	자홍색	파란색	슬레이브 장치 정상
	자홍색	꺼짐	HW 오류
시스템	흰색	빨간색	시스템 잠금 (장치의 작업 조건 및 동작)
	흰색	노란색	시스템 잠금 (BioStar 2의 작업 조건 및 동작)
	흰색	녹색	BioStar 2 연결 성공
	흰색	하늘색	BioStar 2 연결 성공 + 탬퍼 켜짐
	흰색	파란색	탐퍼 켜짐
	흰색	자홍색	시스템 잠금 (장치의 작업 조건 및 동작) + 탬퍼 켜짐
	흰색	흰색	시스템 잠금 (BioStar 2의 작업 조건 및 동작) + 탬퍼 켜짐
	자홍색	자홍색	데이터베이스 마이그레이션 동작 중

설치 예제

CoreStation은 바이오메트릭 인증을 수행할 수 있는 중앙 집중식 출입통제 시스템입니다. 엔터프라이즈급 시스템용으로 설계된 CoreStation은 최대 500,000 명의 사용자 정보를 저장할 수 있으며, 초당 400,000 지문 매칭을 수행할 수 있습니다.

BioStar 2와 연동하여 출입통제와 근태관리를 모두 사용할 수 있으며, RS-485(OSDP), Wiegand, Supervised input, AUX와 같은 다양한 인터페이스를 제공합니다.

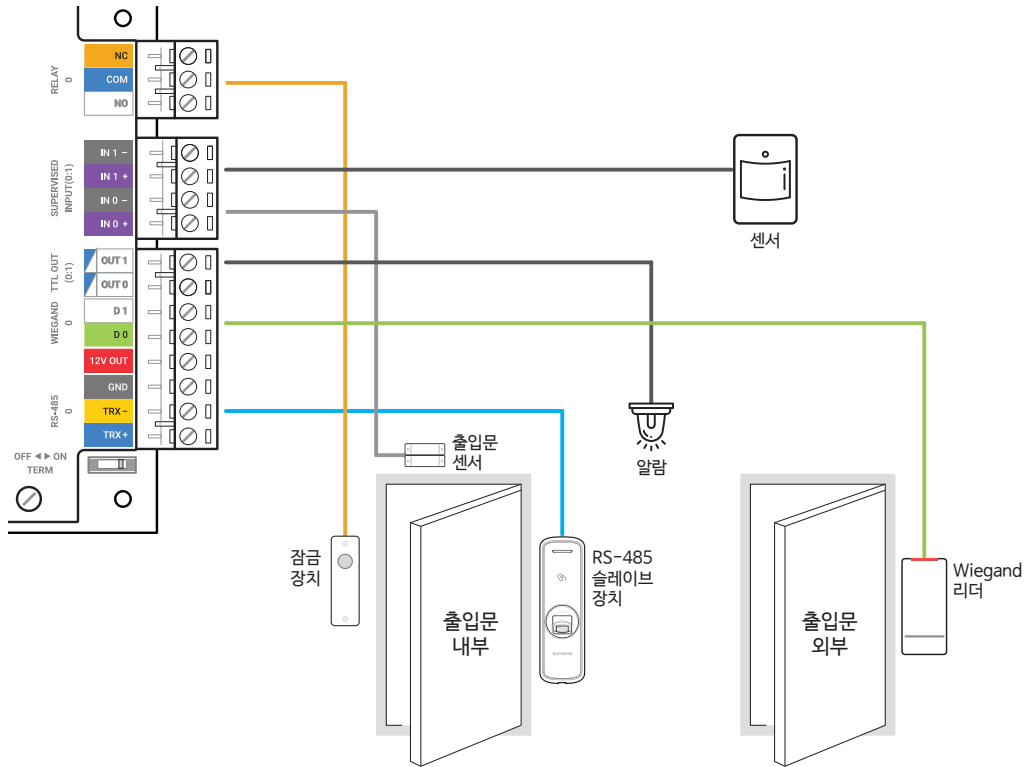

시스템 구성도

CoreStation은 RS-485 장치를 최대 64대까지 연결할 수 있으며, DM-20을 데이지 체인으로 연결하면 Wiegand 장치를 132대까지 확장할 수 있습니다.

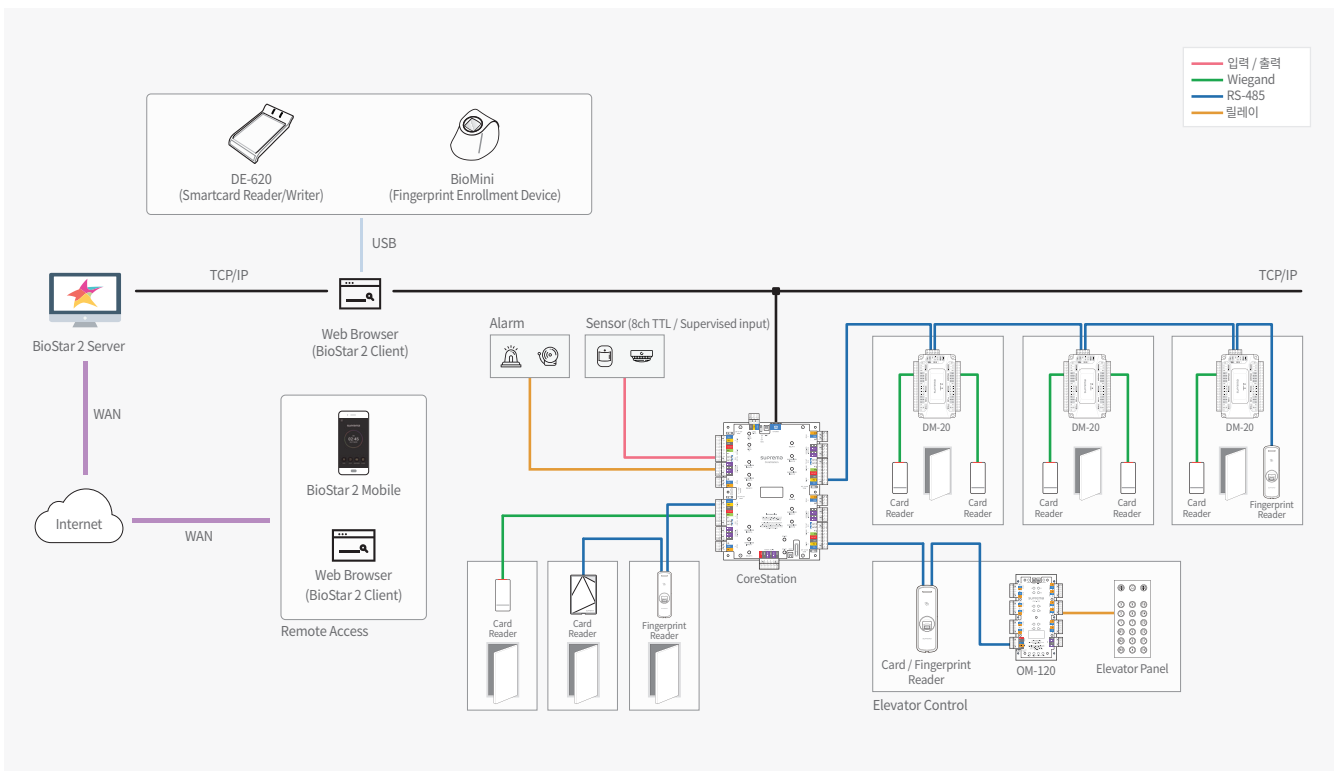

전체 연결 구성도

안정적인 CoreStation의 사용을 위해 전용 합체를 사용할 것을 권장합니다. 합체에는 LED 제어 보드, 전원 제어 보드, 전원 장치, 배터리, 탬퍼가 포함되어 있습니다.

CoreStation STATUS LED

LED	Ethernet	RS-485 0	RS-485 1	RS-485 2	RS-485 3	RS-485 HOST	System
LED 1							
LED 2							
Status	Dynamic IP connection failed Dynamic IP connection Static IP connected Dynamic IP connected Static IP connection failed	No slave device RS-485 disconnected RS-485 working	No slave device RS-485 disconnected RS-485 working	No slave device RS-485 disconnected RS-485 working	No slave device RS-485 disconnected RS-485 working	No slave device RS-485 disconnected RS-485 working	Biostar 2 connected + Tamper on Tamper on Locked by trigger & action of device + Tamper On Locked by trigger & action of Biostar 2 + Tamper On Locked by trigger & action of device

EN The status of CoreStation can be confirmed through STATUS LED 1 / 2 located on the left side from the front unit of the product. These status LEDs show the status of Ethernet, RS-485 0, RS-485 1, RS-485 2, RS-485 3, RS-485 HOST, and system in order for 1 second each.

KO CoreStation의 상태는 제품 전면부의 왼쪽에 위치한 STATUS LED 1 / 2로 확인할 수 있으며, 이더넷, RS-485 0, RS-485 1, RS-485 2, RS-485 3, RS-485 HOST, 시스템의 상태를 1초씩 순서대로 보여줍니다.

POWER / AUX IN (AC Fail, Tamper)

AC INPUT (110-240VAC, 50/60Hz)

ETHERNET

EN CoreStation has automatic MDI/MDI-X function, so it can be connected to a PC directly using a normal type CAT-5e cable.

KO CoreStation은 자동 MDI/MDI-X 기능을 가지고 있으므로 일반 타입의 CAT-5e 케이블로 PC와 직접 연결할 수 있습니다.

Relay | TTL/Supervised Input | TTL Output | Wiegand | Power Output | RS-485

EN

- Connect terminating resistance (120 Ohm) to both ends of the RS-485 daisy chain connection.
- Set the TERM switch to ON for CoreStation.
- CoreStation supports 5 RS-485 ports, and up to 31 devices can be connected to each RS-485 port.
- The number of RS-485 devices connected to CoreStation cannot exceed 64.
- Use an AWG24 twisted pair with a maximum length of 1.2 km for the RS-485 cable.

KO

- RS-485 이더넷 제한 연결의 양 끝에 종단 저항(120 Ohm)을 연결하십시오.
- CoreStation은 종단 저항 스위치(TERM)를 ON으로 설정하십시오.
- CoreStation은 5개의 RS-485 포트를 지원하며 하나의 RS-485 포트에는 최대 31개의 장치를 연결할 수 있습니다.
- CoreStation에 연결된 RS-485 장치는 64대를 초과할 수 없습니다.
- RS-485 케이블은 AWG24, 꼬임선(Twisted Pair), 최대 길이 1.2 km를 사용하십시오.

This device complies with part 15 of the FCC Rules. Operation is subject to the following two conditions: (1) This device may not cause harmful interference, and (2) this device must accept any interference received, including interference that may cause undesired operation.

To get more details and download the guides and Biostar 2, visit www.supremainc.com.



• A 스위치로 제어되는 소켓에 연결하지 마십시오.

설치

- 1 CoreStation을 장착할 위치에 스페이서를 고정용 나사로 고정하십시오.
- 2 고정된 스페이서 위에 고정용 나사로 제품을 단단히 고정하십시오.

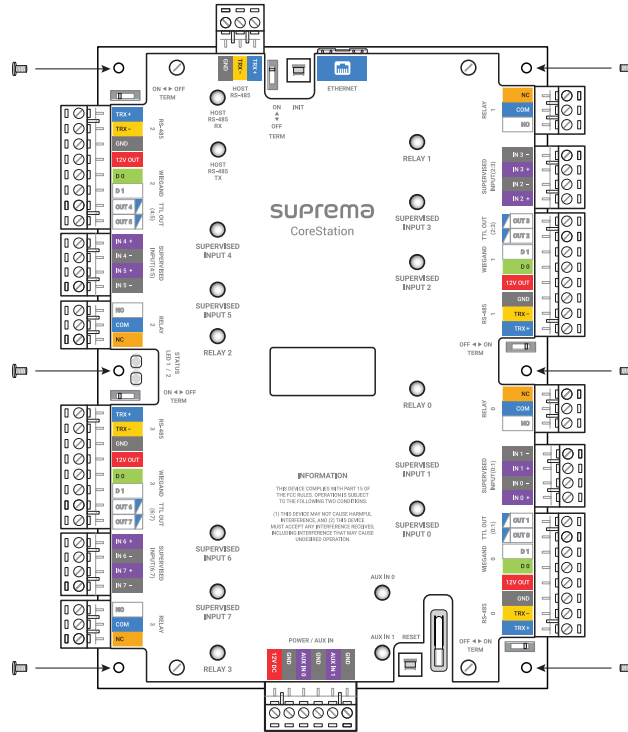

배터리

배터리 벨크로 스트랩을 함체에 끼운 뒤 배터리를 고정하십시오.

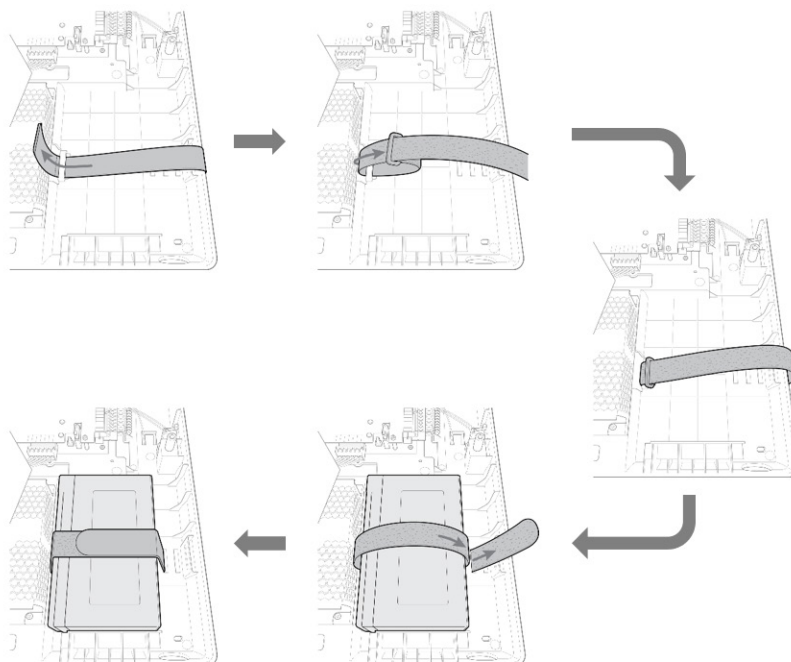

전원 연결

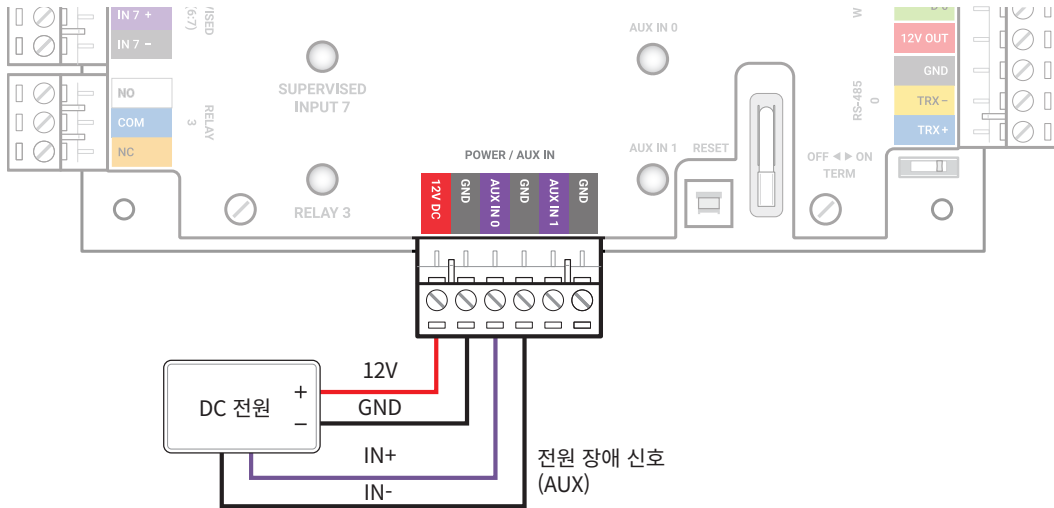

- 출입 통제 장치와 CoreStation에 연결하는 전원은 반드시 분리하여 사용하십시오.
- 올바른 전원 규격(12V, 3A)을 사용하십시오.



- 전원 장애를 막기 위해 무정전 전원 장치(UPS)를 연결하여 사용할 것을 권장합니다.

전원 연결(합체)

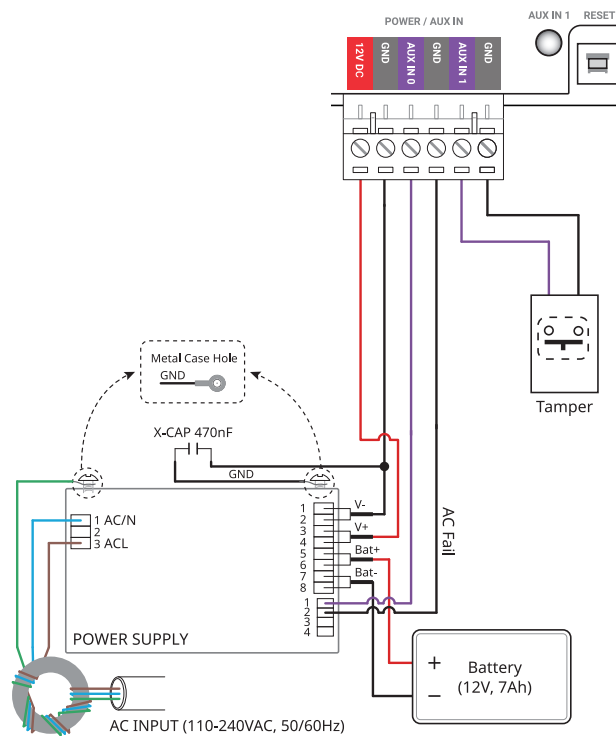

- UL294 설치의 경우 전원이 UL294, UL630, UL864, UL1481 표준 중 하나를 준수해야 합니다.

네트워크 연결

TCP/IP

LAN 연결 (허브와 연결)

일반 타입의 CAT-5 케이블을 사용하여 허브와 연결할 수 있습니다.

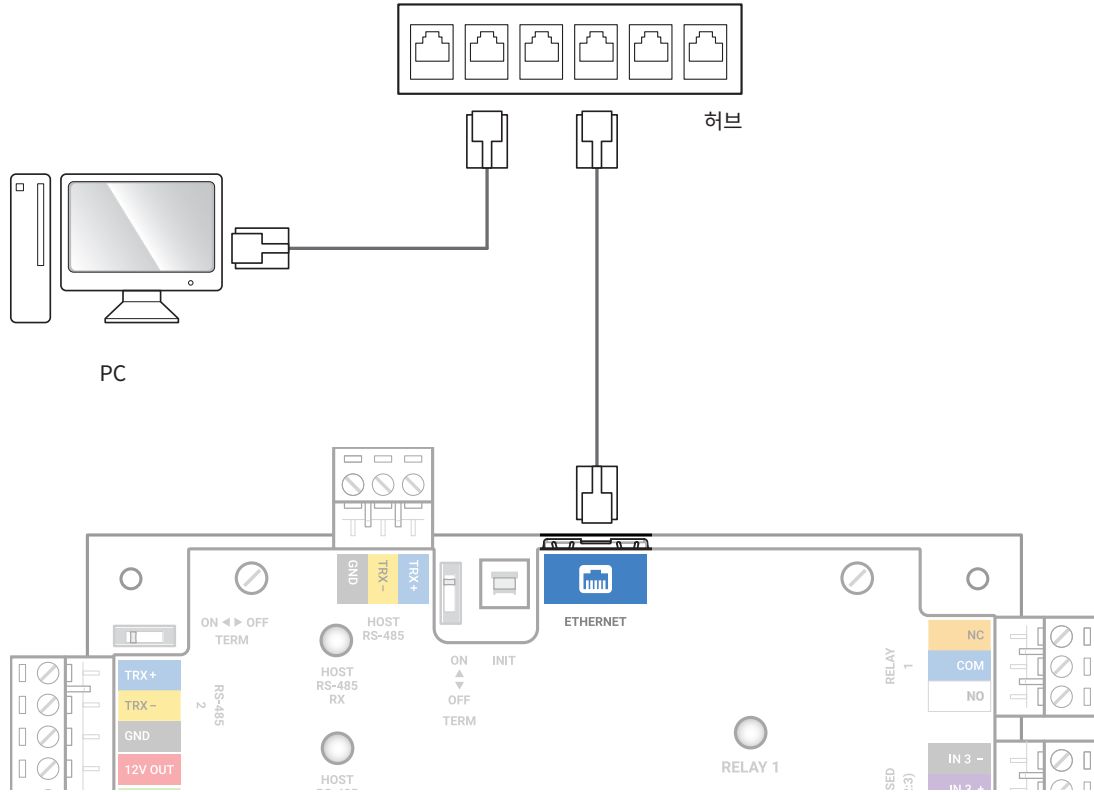

LAN 연결 (PC와 직접 연결)

CoreStation은 자동 MDI/MDI-X 기능을 가지고 있으므로 일반 타입의 CAT-5e 케이블로 PC와 직접 연결할 수 있습니다.

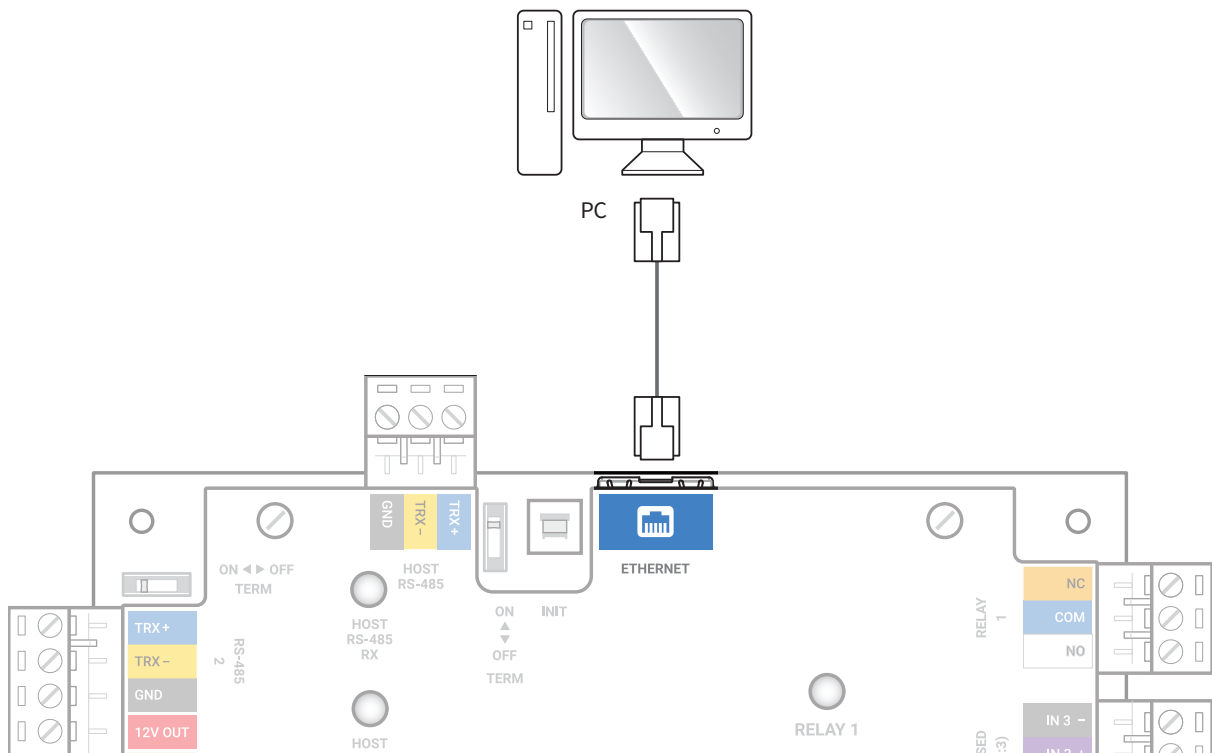

RS-485 연결

CoreStation은 5개의 RS-485 포트를 지원하며 하나의 RS-485 포트에는 최대 31대의 장치를 연결할 수 있습니다.



- CoreStation에 연결된 RS-485 장치는 64대를 초과할 수 없습니다.
- RS-485 케이블은 AWG24, 꼬임선(Twisted Pair), 최대 길이 1.2 km를 사용하십시오.
- RS-485 데이지 체인 연결의 양 끝에 종단 저항(120 Ω)을 연결하십시오. 중간 선로에 연결할 경우 신호 레벨이 작아져 통신 성능이 떨어지므로 반드시 데이지 체인 연결의 양 끝에 연결하십시오. CoreStation은 종단 저항 스위치를 ON으로 설정하십시오.

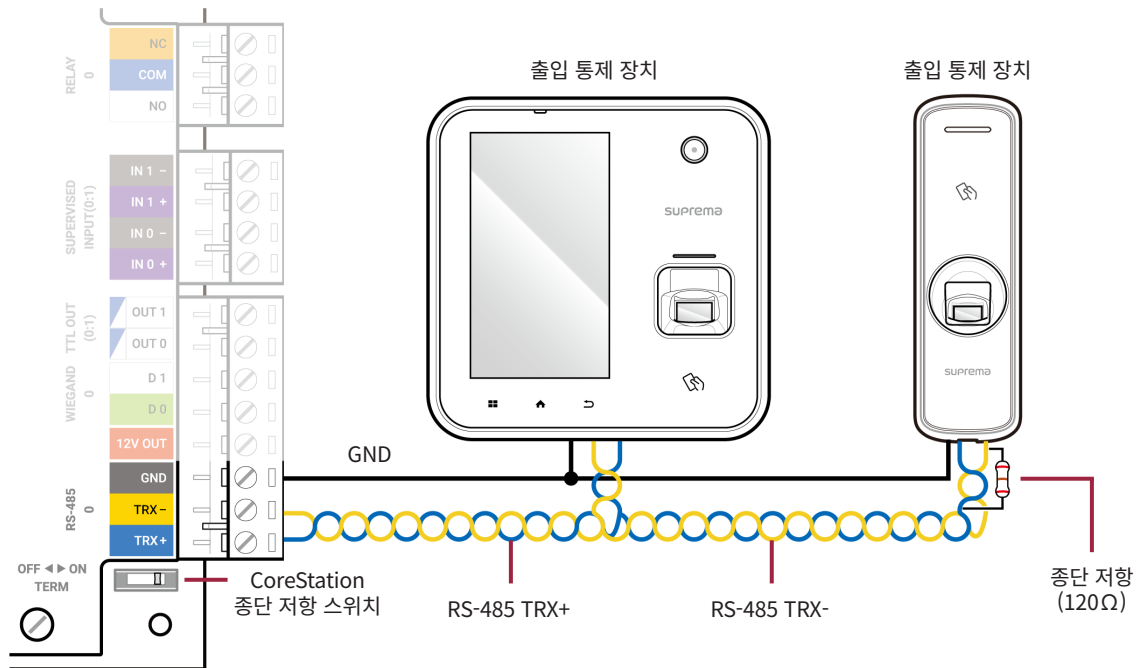

- RS-485 케이블은 AWG26 이상을 사용해야 하며, 모든 배선은 ANSI/NFPA 70 표준을 준수해야 합니다.

릴레이 연결

Fail Safe Lock

Fail Safe Lock을 사용하려면 아래 그림과 같이 N/C 릴레이를 연결하십시오. Fail Safe Lock은 정상 시 릴레이 회로에 전류가 흐르며, 릴레이가 동작하여 전류를 일시적으로 차단하면 출입문이 열립니다. 정전이 되거나 외부 요인으로 장치의 전원이 끊길 경우 출입문이 열립니다.



데드볼트(Deadbolt)나 도어 스트라이크(Door Strike) 설치 시 다이오드를 아래 그림과 같이 전원 입력 양단에 연결하십시오. 다이오드 방향에 주의하여 반드시 Cathode(줄무늬 방향)를 전원의 + 부분에 연결하십시오.

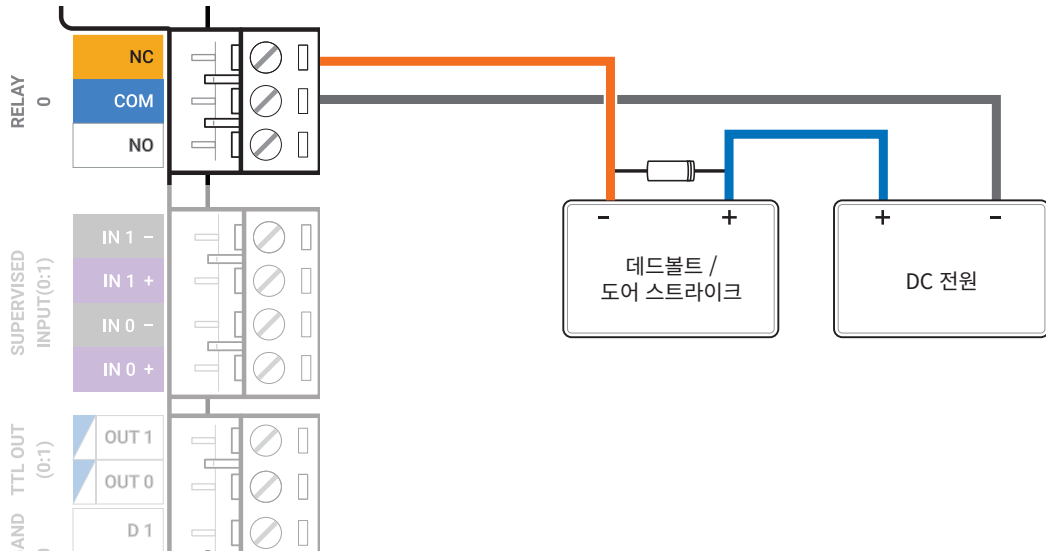

Fail Secure Lock

Fail Secure Lock을 사용하려면 아래 그림과 같이 N/O 릴레이를 연결하십시오. Fail Secure Lock은 정상 시 릴레이 회로에 전류가 흐르지 않으며, 릴레이가 동작하여 전류가 흐르면 출입문이 열립니다. 정전이 되거나 외부 요인으로 장치의 전원이 끊길 경우 출입문이 잠깁니다.



데드볼트(Deadbolt)나 도어 스트라이크(Door Strike) 설치 시 다이오드를 아래 그림과 같이 전원 입력 양단에 연결하십시오. 다이오드 방향에 주의하여 반드시 Cathode(줄무늬 방향)를 전원의 + 부분에 연결하십시오.

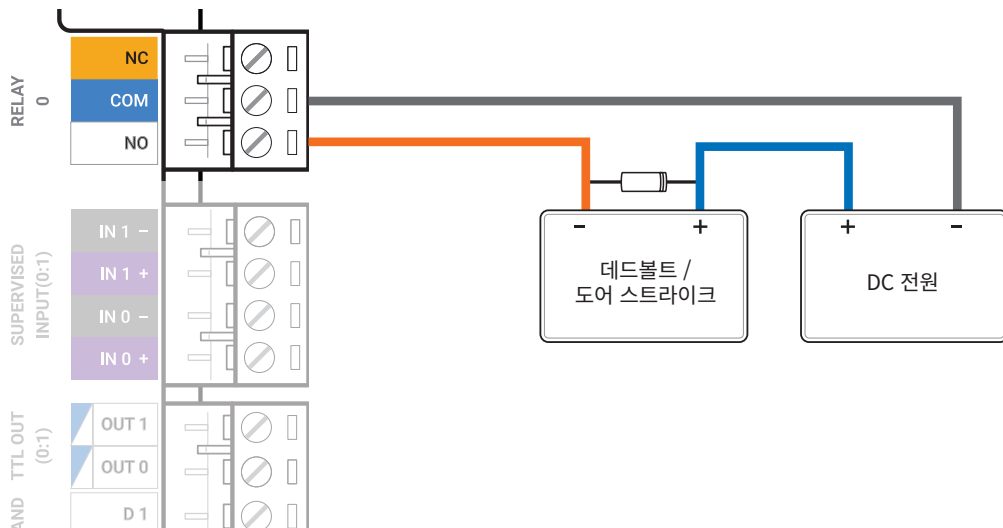

Wiegand 입력 연결

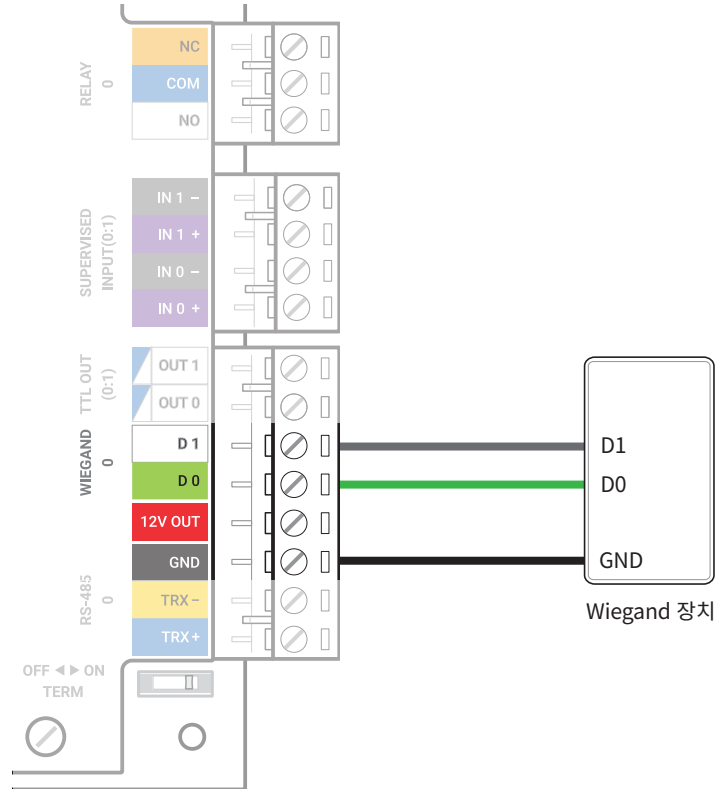

출입문 센서 및 퇴실 버튼 연결

SUPERVISED INPUT 0 ~ 7 단자는 일반적인 TTL 입력으로 사용하거나 Supervised Input으로 사용하도록 설정할 수 있습니다.

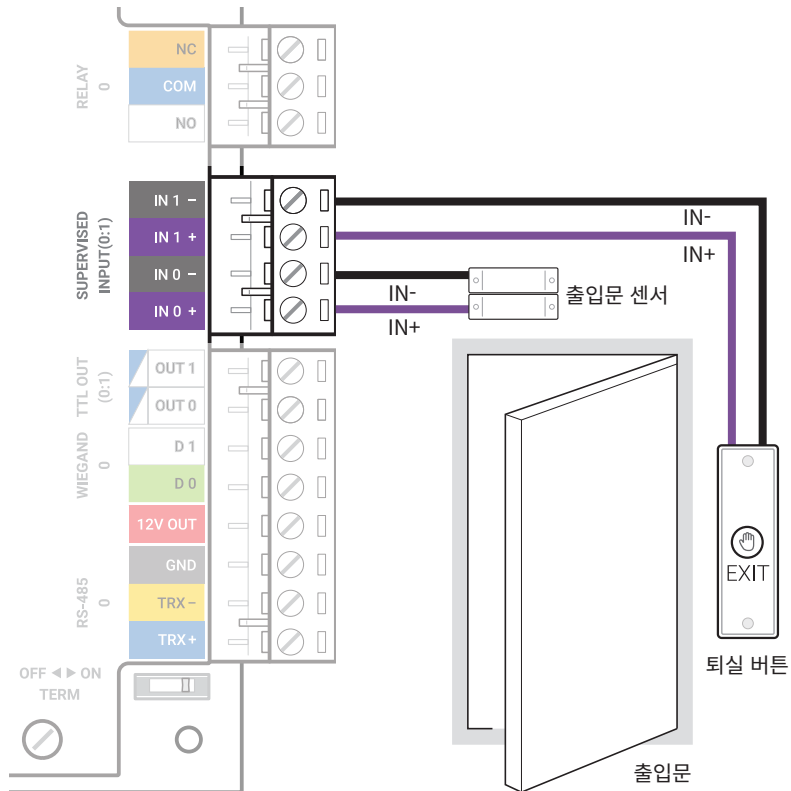

AUX 입력 연결

전원 장애 감지거나 탬퍼를 AUX IN 단자에 연결할 수 있습니다.

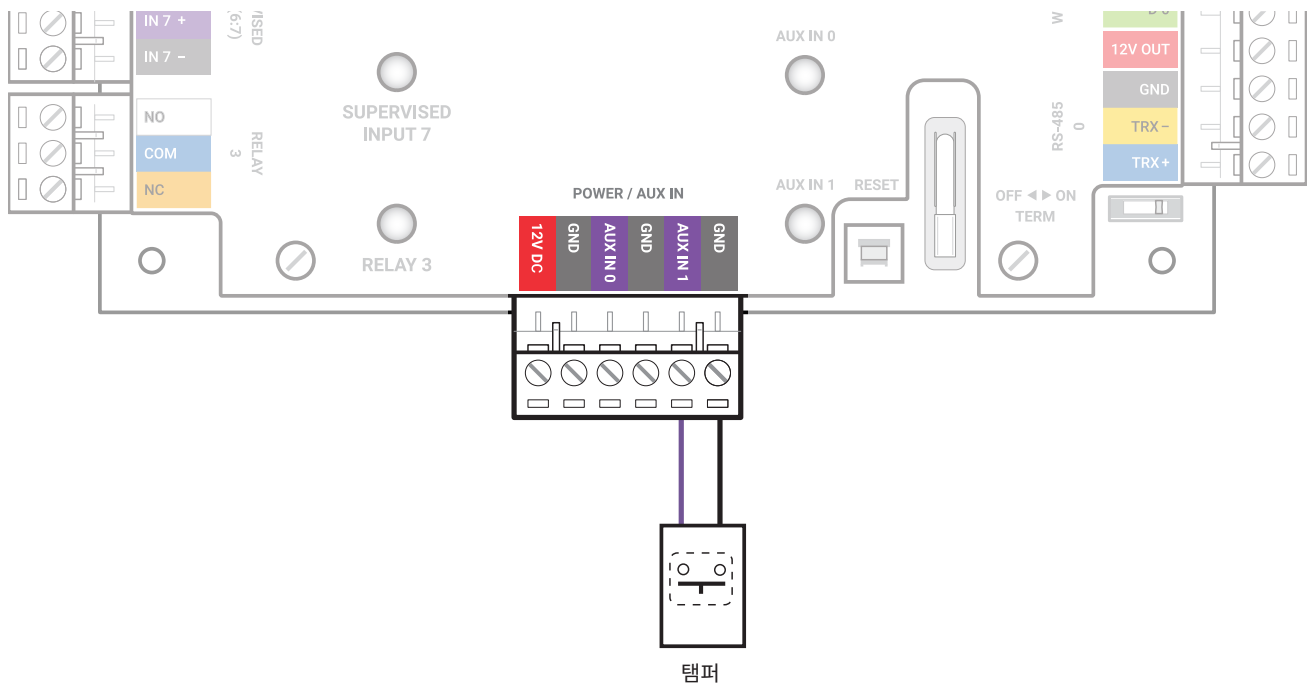

- CoreStation Setup Manager에 접속해 CoreStation의 네트워크 설정을 관리하거나 슬레이브 장치, 입력 및 출력 포트, Wiegand 포트의 연결 상태를 확인할 수 있습니다.
- CoreStation Setup Manager는 CoreStation 펌웨어 1.3.1 버전 이상에서 지원됩니다. 1.3.1보다 낮은 버전의 펌웨어를 사용할 경우 BioStar 2에 접속하여 펌웨어를 최신 버전으로 업그레이드하십시오.
- CoreStation Setup Manager에 대한 자세한 내용은 사용자 가이드를 참고하십시오. 사용자 가이드는 슈프리마 홈페이지 (<https://www.supremainc.com>)에서 내려받을 수 있습니다.
- BioStar 2 최신 버전은 CoreStation이 네트워크에 연결되어 재설정이 가능할 때 확인할 수 있습니다.
- 더 자세한 내용은 슈프리마 기술 지원팀(CS@suprema.co.kr)에 문의하십시오.

제품 사양

구분	항목	규격
일반	모델명	CS-40
	CPU	1.4GHz 옥타코어
	메모리	8 GB Flash + 1 GB RAM
	LED	다중 색상 <ul style="list-style-type: none"> • STATUS - 2개 • HOST RS-485 TX - 1개 • HOST RS-485 RX - 1개 • SUPERVISED INPUT - 8개 • RELAY - 2개 • AUX IN - 2개
	동작 온도	0°C ~ 50°C
	보관 온도	-40°C ~ 70°C
	동작 습도	0% ~ 80%, 비응축
	보관 습도	0% ~ 95%, 비응축
	동작 환경 조건	0°C ~ 49°C
	치수 (W x H x D)	150 mm x 214 mm x 21 mm
무게	415 g	
인증	CE, FCC, KC, RoHS, REACH, WEEE, UL 294 준수	
저장 용량	최대 사용자 수	500,000
	최대 크리덴셜 수 (1:1)	<ul style="list-style-type: none"> • 지문: 500,000 • 얼굴: 30,000 • 카드: 500,000
	최대 크리덴셜 수 (1:N)	<ul style="list-style-type: none"> • 지문: 100,000 • 얼굴: 4,000
	최대 텍스트 로그 수	5,000,000
인터페이스	이더넷	지원 (10/100 Mbps, 자동 MDI/MDI-X)
	RS-485	5 채널
	Wiegand	4 채널
	Supervised 입력	8 채널 (TTL 입력 선택 가능)
	TTL 출력	8 채널
	AUX 입력	2 채널 (AC POWER FAIL, 탬퍼 연결 지원)
전기 규격	전원	CoreStation - 전압: 12 VDC, 전류: 최대 3 A 전원 장치 (SMPS) AC INPUT - 110-240 VAC, 50/60 Hz
	전원 출력	전압: 12 VDC 전류: 최대 1.5 A
	스위치 입력 VIH	최대: 5 V 최소: 4 V
	스위치 입력 VIL	최대 1 V
	릴레이	전압: 최대 30 VDC 전류: 최대 5 A

* 얼굴 인식 장치는 FaceStation 2, FaceLite만 지원됩니다.



- 완전한 출입통제 시스템을 갖추기 위해 모든 주변 장치(카드 리더, 키패드, 지문 인식 장치)는 UL294를 준수해야 합니다.
- CoreStation 제품이나 문제 해결을 위한 자세한 정보는 다음 링크를 참고하십시오.
http://kb.supremainc.com/knowledge/doku.php?id=en:14_subjects_of_corestation_fa

제품 치수

(단위: mm)

* 치수 공차는 ±0.3 mm입니다.

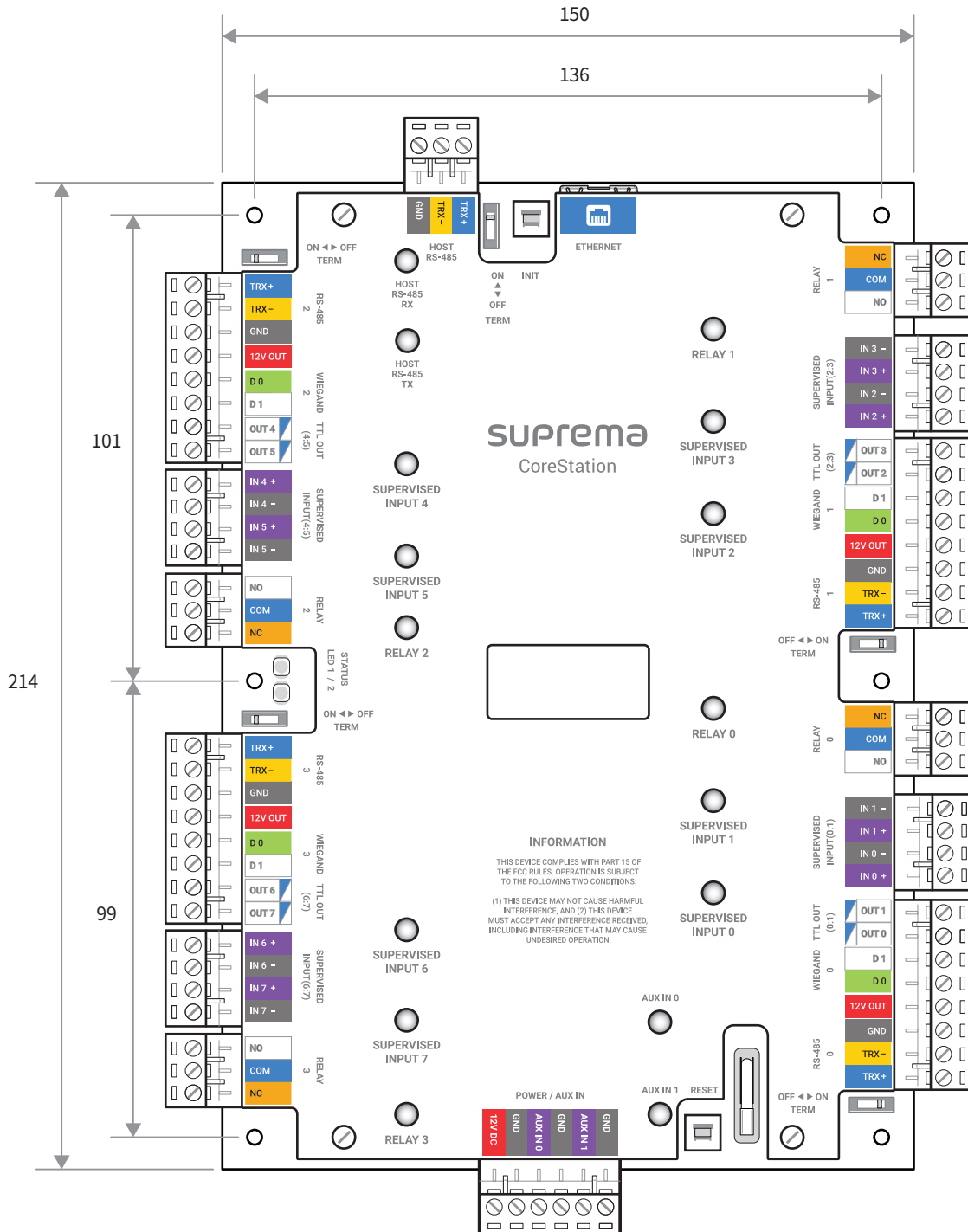

FCC 준수 정보

이 기기는 FCC 규제의 Part 15를 준수합니다.
작동은 다음의 두 조건을 따릅니다.

- (1) 이 기기는 해로운 전파 방해를 발생시키지 않습니다.
- (2) 이 기기는 원치 않는 작동을 일으키는 전파 방해를 포함한 어떠한 전파 방해도 수용합니다.



이 기기는 Class A 디지털 기기에 대한 제한 사항을 준수하여 테스트를 거쳤고 FCC규제의 Part 15에 적합하다는 것을 검증받았습니다. 이러한 제한은 주거 설치에서 해로운 전파방해로부터 적절한 수준의 보호를 제공하기 위해 고안되었습니다. 이 장비는 무선 주파수 에너지를 생성, 사용 및 방사하므로 지침에 따라 설치하여 사용하지 않을 경우 무선 통신에서 유해한 간섭을 일으킬 수 있습니다. 그러나 특정한 설치에서는 전파방해가 발생하지 않는다는 어떠한 보장도 하지 않습니다. 본 장비를 켜거나 끌 때 라디오 또는 TV 수신에 해로운 전파방해를 일으키는 경우, 다음 중 하나 이상의 조치를 수행하여 전파방해를 해결하십시오.

- 수신 안테나의 방향을 조정하거나 재설치합니다.
- 장비와 수신기 사이의 간격을 늘립니다.
- 장비를 수신기가 연결된 회로와 다른 회로의 콘센트에 연결합니다.
- 판매업체나 숙련된 라디오/TV 기술자에게 문의합니다.

제조 업체가 승인하지 않은 제품 변경 또는 개조에 대해서는 FCC 규칙에 따라 제품을 사용할 수 있는 권리가 무효화 됩니다.

- 이 제품과 제품의 안테나를 다른 안테나 또는 RF 전송 장치와 함께 설치하지 마십시오.
- 사용자(또는 근처의 다른 사람)와 제품의 안테나간에 최소 20cm의 거리를 유지하십시오.

면책 조항

- 이 설명서에 있는 정보는 슈프리마 제품과 관련하여 제공하는 것입니다.
- 슈프리마가 보장하는 판매 합의사항과 조건에 포함된 제품에 한해서만 사용 권리가 인정됩니다. 이 설명서에서 다루고 있는 그 이외의 지적 재산권에 대한 라이선스 권리는 인정되지 않습니다.
- 슈프리마는 슈프리마 제품의 판매 또는 사용과 관련하여, 특정 목적을 위한 제품의 적합성과 상업성, 그리고 특허, 저작권, 기타 지적 재산권의 침해에 대해서는 어떠한 보증이나 책임을 지지 않습니다.
- 의료, 인명 구조, 생명 유지와 관련된 상황이나 제품의 오작동으로 인해 사람이 다치거나 목숨을 잃을 수 있는 상황에서는 슈프리마의 제품을 사용하지 마십시오. 만약 구매자가 앞에 예로 든 상황에서 제품을 사용하다가 사고가 발생한다면, 설사 제품의 설계나 생산 과정에서 부족한 점이 발견되어 이를 중요한 과실로 주장한다 하더라도 슈프리마의 직원, 자회사, 지사, 제휴사, 배포사는 책임을 지지 않으며, 변호사 선임비를 포함하여 이와 관련한 모든 직간접적인 비용이나 지출에 대해서도 변제하지 않습니다.
- 슈프리마는 제품의 안정성, 기능, 디자인을 개선하기 위해 적절한 공지 없이 어느 때이건 제품의 규격과 명세서를 변경할 수도 있습니다. 설계자들은 "구현될 예정"이나 "정의되지 않음"으로 표시된 기능이나 설명은 항상 변동될 수 있다는 점을 염두에 두어야 합니다. 슈프리마는 멀지 않은 미래에 이러한 것들을 구현하거나 정의할 것이며, 호환성의 문제를 포함하여 이로 인해 발생할 수 있는 어떠한 문제점에 대해서도 책임을 지지 않습니다.
- 제품을 주문하기 전에 가장 최신의 규격서를 얻고자 한다면 슈프리마, 슈프리마의 판매 대행사, 지역 배포사에 문의하십시오.

저작권 공지

이 문서의 저작권은 슈프리마에게 있습니다. 다른 제품 이름, 상표, 등록된 상표에 대한 권리는 각각 그것을 소유한 개인이나 단체에게 있습니다.

오픈 소스 라이선스

- 이 제품의 소프트웨어는 Linux 커널 3.x 버전을 수정하여 제작되었으며, Linux 커널의 라이선스는 GPL을 따르고 있습니다. GPL 라이선스는 이 매뉴얼의 [GNU General Public License](#)에서 확인할 수 있습니다.
- 이 제품에 포함된 glibc 라이브러리는 LGPL을 따릅니다. LGPL 라이선스는 이 매뉴얼의 [GNU Lesser General Public License](#)에서 확인할 수 있습니다.
- 이 제품에 포함된 QT 라이브러리는 LGPL을 따릅니다. LGPL 라이선스는 이 매뉴얼의 [GNU Lesser General Public License](#)에서 확인할 수 있습니다.
- 이 제품에 포함된 OpenSSL은 OpenSSL 라이선스와 Original SSLeay 라이선스를 따릅니다. OpenSSL 라이선스와 Original SSLeay 라이선스는 이 매뉴얼의 [OpenSSL License](#)와 [Original SSLeay License](#)에서 확인할 수 있습니다.
- 이 제품에 포함된 Linux 커널 3.x 기반으로 수정된 소스와 glibc 라이브러리, QT 라이브러리는 support.supremainc.com으로 문의하여 다운로드 받을 수 있습니다.

GNU General Public License

Version 3, 29 June 2007

Copyright © 2007 Free Software Foundation, Inc. <<http://fsf.org/>>

Everyone is permitted to copy and distribute verbatim copies of this license document, but changing it is not allowed.

Preamble

The GNU General Public License is a free, copyleft license for software and other kinds of works.

The licenses for most software and other practical works are designed to take away your freedom to share and change the works. By contrast, the GNU General Public License is intended to guarantee your freedom to share and change all versions of a program--to make sure it remains free software for all its users. We, the Free Software Foundation, use the GNU General Public License for most of our software; it applies also to any other work released this way by its authors. You can apply it to your programs, too.

When we speak of free software, we are referring to freedom, not price. Our General Public Licenses are designed to make sure that you have the freedom to distribute copies of free software (and charge for them if you wish), that you receive source code or can get it if you want it, that you can change the software or use pieces of it in new free programs, and that you know you can do these things.

To protect your rights, we need to prevent others from denying you these rights or asking you to surrender the rights. Therefore, you have certain responsibilities if you distribute copies of the software, or if you modify it: responsibilities to respect the freedom of others.

For example, if you distribute copies of such a program, whether gratis or for a fee, you must pass on to the recipients the same freedoms that you received. You must make sure that they, too, receive or can get the source code. And you must show them these terms so they know their rights.

Developers that use the GNU GPL protect your rights with two steps: (1) assert copyright on the software, and (2) offer you this License giving you legal permission to copy, distribute and/or modify it.

For the developers' and authors' protection, the GPL clearly explains that there is no warranty for this free software. For both users' and authors' sake, the GPL requires that modified versions be marked as changed, so that their problems will not be attributed erroneously to authors of previous versions.

Some devices are designed to deny users access to install or run modified versions of the software inside them, although the manufacturer can do so. This is fundamentally incompatible with the aim of protecting users' freedom to change the software. The systematic pattern of such abuse occurs in the area of products for individuals to use, which is precisely where it is most unacceptable. Therefore, we have designed this version of the GPL to prohibit the practice for those products. If such problems arise substantially in other domains, we stand ready to extend this provision to those domains in future versions of the GPL, as needed to protect the freedom of users.

Finally, every program is threatened constantly by software patents. States should not allow patents to restrict development and use of software on general-purpose computers, but in those that do, we wish to avoid the special danger that patents applied to a free program could make it effectively proprietary. To prevent this, the GPL assures that patents cannot be used to render the program non-free.

The precise terms and conditions for copying, distribution and modification follow.

TERMS AND CONDITIONS

0. Definitions.

“This License” refers to version 3 of the GNU General Public License.

“Copyright” also means copyright-like laws that apply to other kinds of works, such as semiconductor masks.

“The Program” refers to any copyrightable work licensed under this License. Each licensee is addressed as “you”.

“Licensees” and “recipients” may be individuals or organizations.

To “modify” a work means to copy from or adapt all or part of the work in a fashion requiring copyright permission, other than the making of an exact copy. The resulting work is called a “modified version” of the earlier work or a work “based on” the earlier work.

A “covered work” means either the unmodified Program or a work based on the Program.

To “propagate” a work means to do anything with it that, without permission, would make you directly or secondarily liable for infringement under applicable copyright law, except executing it on a computer or modifying a private copy. Propagation includes copying, distribution (with or without modification), making available to the public, and in some countries other activities as well.

To “convey” a work means any kind of propagation that enables other parties to make or receive copies. Mere interaction with a user through a computer network, with no transfer of a copy, is not conveying.

An interactive user interface displays “Appropriate Legal Notices” to the extent that it includes a convenient and prominently visible feature that (1) displays an appropriate copyright notice, and (2) tells the user that there is no warranty for the work (except to the extent that warranties are provided), that licensees may convey the work under this License, and how to view a copy of this License. If the interface presents a list of user commands or options, such as a menu, a prominent item in the list meets this criterion.

1. Source Code.

The “source code” for a work means the preferred form of the work for making modifications to it. “Object code” means any non-source form of a work.

A “Standard Interface” means an interface that either is an official standard defined by a recognized standards body, or, in the case of interfaces specified for a particular programming language, one that is widely used among developers working in that language.

The “System Libraries” of an executable work include anything, other than the work as a whole, that (a) is included in the normal form of packaging a Major Component, but which is not part of that Major Component, and (b) serves only to enable use of the work with that Major Component, or to implement a Standard Interface for which an implementation is available to the public in source code form. A “Major Component”, in this context, means a major essential component (kernel, window system, and so on) of the specific operating system (if any) on which the executable work runs, or a compiler used to produce the work, or an object code interpreter used to run it.

The “Corresponding Source” for a work in object code form means all the source code needed to generate, install, and (for an executable work) run the object code and to modify the work, including scripts to control those activities. However, it does not include the work’s System Libraries, or general-purpose tools or generally available free programs which are used unmodified in performing those activities but which are not part of the work. For example, Corresponding Source includes interface definition files associated with source files for the work, and the source code for shared libraries and dynamically linked subprograms that the work is specifically designed to require, such as by intimate data communication or control flow between those subprograms and other parts of the work.

The Corresponding Source need not include anything that users can regenerate automatically from other parts of the Corresponding Source.

The Corresponding Source for a work in source code form is that same work.

2. Basic Permissions.

All rights granted under this License are granted for the term of copyright on the Program, and are irrevocable provided the stated conditions are met. This License explicitly affirms your unlimited permission to run the unmodified Program. The output from running a covered work is covered by this License only if the output, given its content, constitutes a covered work. This License acknowledges your rights of fair use or other equivalent, as provided by copyright law.

You may make, run and propagate covered works that you do not convey, without conditions so long as your license otherwise remains in force. You may convey covered works to others for the sole purpose of having them make modifications exclusively for you, or provide you with facilities for running those works, provided that you comply with the terms of this License in conveying all material for which you do not control copyright. Those thus making or running the covered works for you must do so exclusively on your behalf, under your direction and control, on terms that prohibit them from making any copies of your copyrighted material outside their relationship with you.

Conveying under any other circumstances is permitted solely under the conditions stated below. Sublicensing is not allowed; section 10 makes it unnecessary.

3. Protecting Users' Legal Rights From Anti-Circumvention Law.

No covered work shall be deemed part of an effective technological measure under any applicable law fulfilling obligations under article 11 of the WIPO copyright treaty adopted on 20 December 1996, or similar laws prohibiting or restricting circumvention of such measures.

When you convey a covered work, you waive any legal power to forbid circumvention of technological measures to the extent such circumvention is effected by exercising rights under this License with respect to the covered work, and you disclaim any intention to limit operation or modification of the work as a means of enforcing, against the work's users, your or third parties' legal rights to forbid circumvention of technological measures.

4. Conveying Verbatim Copies.

You may convey verbatim copies of the Program's source code as you receive it, in any medium, provided that you conspicuously and appropriately publish on each copy an appropriate copyright notice; keep intact all notices stating that this License and any non-permissive terms added in accord with section 7 apply to the code; keep intact all notices of the absence of any warranty; and give all recipients a copy of this License along with the Program.

You may charge any price or no price for each copy that you convey, and you may offer support or warranty protection for a fee.

5. Conveying Modified Source Versions.

You may convey a work based on the Program, or the modifications to produce it from the Program, in the form of source code under the terms of section 4, provided that you also meet all of these conditions:

- a) The work must carry prominent notices stating that you modified it, and giving a relevant date.
- b) The work must carry prominent notices stating that it is released under this License and any conditions added under section 7. This requirement modifies the requirement in section 4 to "keep intact all notices".
- c) You must license the entire work, as a whole, under this License to anyone who comes into possession of a copy. This License will therefore apply, along with any applicable section 7 additional terms, to the whole of the work, and all its parts, regardless of how they are packaged. This License gives no permission to license the work in any other way, but it does not invalidate such permission if you have separately received it.
- d) If the work has interactive user interfaces, each must display Appropriate Legal Notices; however, if the Program has interactive interfaces that do not display Appropriate Legal Notices, your work need not make them do so.

A compilation of a covered work with other separate and independent works, which are not by their nature extensions of the covered work, and which are not combined with it such as to form a larger program, in or on a volume of a storage or distribution medium, is called an "aggregate" if the compilation and its resulting copyright are not used to limit the access or legal rights of the compilation's users beyond what the individual works permit. Inclusion of a covered work in an aggregate does not cause this License to apply to the other parts of the aggregate.

6. Conveying Non-Source Forms.

You may convey a covered work in object code form under the terms of sections 4 and 5, provided that you also convey the machine-readable Corresponding Source under the terms of this License, in one of these ways:

- a) Convey the object code in, or embodied in, a physical product (including a physical distribution medium), accompanied by the Corresponding Source fixed on a durable physical medium customarily used for software interchange.
- b) Convey the object code in, or embodied in, a physical product (including a physical distribution medium), accompanied by a written offer, valid for at least three years and valid for as long as you offer spare parts or customer support for that product model, to give anyone who possesses the object code either (1) a copy of the Corresponding Source for all the software in the product that is covered by this License, on a durable physical medium customarily used for software interchange, for a price no more than your reasonable cost of physically performing this conveying of source, or (2) access to copy the Corresponding Source from a network server at no charge.
- c) Convey individual copies of the object code with a copy of the written offer to provide the Corresponding Source. This alternative is allowed only occasionally and noncommercially, and only if you received the object code with such an offer, in accord with subsection 6b.

- d) Convey the object code by offering access from a designated place (gratis or for a charge), and offer equivalent access to the Corresponding Source in the same way through the same place at no further charge. You need not require recipients to copy the Corresponding Source along with the object code. If the place to copy the object code is a network server, the Corresponding Source may be on a different server (operated by you or a third party) that supports equivalent copying facilities, provided you maintain clear directions next to the object code saying where to find the Corresponding Source. Regardless of what server hosts the Corresponding Source, you remain obligated to ensure that it is available for as long as needed to satisfy these requirements.
- e) Convey the object code using peer-to-peer transmission, provided you inform other peers where the object code and Corresponding Source of the work are being offered to the general public at no charge under subsection 6d.

A separable portion of the object code, whose source code is excluded from the Corresponding Source as a System Library, need not be included in conveying the object code work.

A “User Product” is either (1) a “consumer product”, which means any tangible personal property which is normally used for personal, family, or household purposes, or (2) anything designed or sold for incorporation into a dwelling. In determining whether a product is a consumer product, doubtful cases shall be resolved in favor of coverage. For a particular product received by a particular user, “normally used” refers to a typical or common use of that class of product, regardless of the status of the particular user or of the way in which the particular user actually uses, or expects or is expected to use, the product. A product is a consumer product regardless of whether the product has substantial commercial, industrial or non-consumer uses, unless such uses represent the only significant mode of use of the product.

“Installation Information” for a User Product means any methods, procedures, authorization keys, or other information required to install and execute modified versions of a covered work in that User Product from a modified version of its Corresponding Source. The information must suffice to ensure that the continued functioning of the modified object code is in no case prevented or interfered with solely because modification has been made.

If you convey an object code work under this section in, or with, or specifically for use in, a User Product, and the conveying occurs as part of a transaction in which the right of possession and use of the User Product is transferred to the recipient in perpetuity or for a fixed term (regardless of how the transaction is characterized), the Corresponding Source conveyed under this section must be accompanied by the Installation Information. But this requirement does not apply if neither you nor any third party retains the ability to install modified object code on the User Product (for example, the work has been installed in ROM).

The requirement to provide Installation Information does not include a requirement to continue to provide support service, warranty, or updates for a work that has been modified or installed by the recipient, or for the User Product in which it has been modified or installed. Access to a network may be denied when the modification itself materially and adversely affects the operation of the network or violates the rules and protocols for communication across the network.

Corresponding Source conveyed, and Installation Information provided, in accord with this section must be in a format that is publicly documented (and with an implementation available to the public in source code form), and must require no special password or key for unpacking, reading or copying.

7. Additional Terms.

“Additional permissions” are terms that supplement the terms of this License by making exceptions from one or more of its conditions. Additional permissions that are applicable to the entire Program shall be treated as though they were included in this License, to the extent that they are valid under applicable law. If additional permissions apply only to part of the Program, that part may be used separately under those permissions, but the entire Program remains governed by this License without regard to the additional permissions.

When you convey a copy of a covered work, you may at your option remove any additional permissions from that copy, or from any part of it. (Additional permissions may be written to require their own removal in certain cases when you modify the work.) You may place additional permissions on material, added by you to a covered work, for which you have or can give appropriate copyright permission.

Notwithstanding any other provision of this License, for material you add to a covered work, you may (if authorized by the copyright holders of that material) supplement the terms of this License with terms:

- a) Disclaiming warranty or limiting liability differently from the terms of sections 15 and 16 of this License; or
- b) Requiring preservation of specified reasonable legal notices or author attributions in that material or in the Appropriate Legal Notices displayed by works containing it; or
- c) Prohibiting misrepresentation of the origin of that material, or requiring that modified versions of such material be marked in reasonable ways as different from the original version; or

- d) Limiting the use for publicity purposes of names of licensors or authors of the material; or
- e) Declining to grant rights under trademark law for use of some trade names, trademarks, or service marks; or
- f) Requiring indemnification of licensors and authors of that material by anyone who conveys the material (or modified versions of it) with contractual assumptions of liability to the recipient, for any liability that these contractual assumptions directly impose on those licensors and authors.

All other non-permissive additional terms are considered “further restrictions” within the meaning of section 10. If the Program as you received it, or any part of it, contains a notice stating that it is governed by this License along with a term that is a further restriction, you may remove that term. If a license document contains a further restriction but permits relicensing or conveying under this License, you may add to a covered work material governed by the terms of that license document, provided that the further restriction does not survive such relicensing or conveying.

If you add terms to a covered work in accord with this section, you must place, in the relevant source files, a statement of the additional terms that apply to those files, or a notice indicating where to find the applicable terms.

Additional terms, permissive or non-permissive, may be stated in the form of a separately written license, or stated as exceptions; the above requirements apply either way.

8. Termination.

You may not propagate or modify a covered work except as expressly provided under this License. Any attempt otherwise to propagate or modify it is void, and will automatically terminate your rights under this License (including any patent licenses granted under the third paragraph of section 11).

However, if you cease all violation of this License, then your license from a particular copyright holder is reinstated (a) provisionally, unless and until the copyright holder explicitly and finally terminates your license, and (b) permanently, if the copyright holder fails to notify you of the violation by some reasonable means prior to 60 days after the cessation.

Moreover, your license from a particular copyright holder is reinstated permanently if the copyright holder notifies you of the violation by some reasonable means, this is the first time you have received notice of violation of this License (for any work) from that copyright holder, and you cure the violation prior to 30 days after your receipt of the notice.

Termination of your rights under this section does not terminate the licenses of parties who have received copies or rights from you under this License. If your rights have been terminated and not permanently reinstated, you do not qualify to receive new licenses for the same material under section 10.

9. Acceptance Not Required for Having Copies.

You are not required to accept this License in order to receive or run a copy of the Program. Ancillary propagation of a covered work occurring solely as a consequence of using peer-to-peer transmission to receive a copy likewise does not require acceptance. However, nothing other than this License grants you permission to propagate or modify any covered work. These actions infringe copyright if you do not accept this License. Therefore, by modifying or propagating a covered work, you indicate your acceptance of this License to do so.

10. Automatic Licensing of Downstream Recipients.

Each time you convey a covered work, the recipient automatically receives a license from the original licensors, to run, modify and propagate that work, subject to this License. You are not responsible for enforcing compliance by third parties with this License.

An “entity transaction” is a transaction transferring control of an organization, or substantially all assets of one, or subdividing an organization, or merging organizations. If propagation of a covered work results from an entity transaction, each party to that transaction who receives a copy of the work also receives whatever licenses to the work the party’s predecessor in interest had or could give under the previous paragraph, plus a right to possession of the Corresponding Source of the work from the predecessor in interest, if the predecessor has it or can get it with reasonable efforts.

You may not impose any further restrictions on the exercise of the rights granted or affirmed under this License. For example, you may not impose a license fee, royalty, or other charge for exercise of rights granted under this License, and you may not initiate litigation (including a cross-claim or counterclaim in a lawsuit) alleging that any patent claim is infringed by making, using, selling, offering for sale, or importing the Program or any portion of it.

11. Patents.

A “contributor” is a copyright holder who authorizes use under this License of the Program or a work on which the Program is based. The work thus licensed is called the contributor's “contributor version”.

A contributor's “essential patent claims” are all patent claims owned or controlled by the contributor, whether already acquired or hereafter acquired, that would be infringed by some manner, permitted by this License, of making, using, or selling its contributor version, but do not include claims that would be infringed only as a consequence of further modification of the contributor version. For purposes of this definition, “control” includes the right to grant patent sublicenses in a manner consistent with the requirements of this License.

Each contributor grants you a non-exclusive, worldwide, royalty-free patent license under the contributor's essential patent claims, to make, use, sell, offer for sale, import and otherwise run, modify and propagate the contents of its contributor version.

In the following three paragraphs, a “patent license” is any express agreement or commitment, however denominated, not to enforce a patent (such as an express permission to practice a patent or covenant not to sue for patent infringement). To “grant” such a patent license to a party means to make such an agreement or commitment not to enforce a patent against the party.

If you convey a covered work, knowingly relying on a patent license, and the Corresponding Source of the work is not available for anyone to copy, free of charge and under the terms of this License, through a publicly available network server or other readily accessible means, then you must either (1) cause the Corresponding Source to be so available, or (2) arrange to deprive yourself of the benefit of the patent license for this particular work, or (3) arrange, in a manner consistent with the requirements of this License, to extend the patent license to downstream recipients. “Knowingly relying” means you have actual knowledge that, but for the patent license, your conveying the covered work in a country, or your recipient's use of the covered work in a country, would infringe one or more identifiable patents in that country that you have reason to believe are valid.

If, pursuant to or in connection with a single transaction or arrangement, you convey, or propagate by procuring conveyance of, a covered work, and grant a patent license to some of the parties receiving the covered work authorizing them to use, propagate, modify or convey a specific copy of the covered work, then the patent license you grant is automatically extended to all recipients of the covered work and works based on it.

A patent license is “discriminatory” if it does not include within the scope of its coverage, prohibits the exercise of, or is conditioned on the non-exercise of one or more of the rights that are specifically granted under this License. You may not convey a covered work if you are a party to an arrangement with a third party that is in the business of distributing software, under which you make payment to the third party based on the extent of your activity of conveying the work, and under which the third party grants, to any of the parties who would receive the covered work from you, a discriminatory patent license (a) in connection with copies of the covered work conveyed by you (or copies made from those copies), or (b) primarily for and in connection with specific products or compilations that contain the covered work, unless you entered into that arrangement, or that patent license was granted, prior to 28 March 2007.

Nothing in this License shall be construed as excluding or limiting any implied license or other defenses to infringement that may otherwise be available to you under applicable patent law.

12. No Surrender of Others' Freedom.

If conditions are imposed on you (whether by court order, agreement or otherwise) that contradict the conditions of this License, they do not excuse you from the conditions of this License. If you cannot convey a covered work so as to satisfy simultaneously your obligations under this License and any other pertinent obligations, then as a consequence you may not convey it at all. For example, if you agree to terms that obligate you to collect a royalty for further conveying from those to whom you convey the Program, the only way you could satisfy both those terms and this License would be to refrain entirely from conveying the Program.

13. Use with the GNU Affero General Public License.

Notwithstanding any other provision of this License, you have permission to link or combine any covered work with a work licensed under version 3 of the GNU Affero General Public License into a single combined work, and to convey the resulting work. The terms of this License will continue to apply to the part which is the covered work, but the special requirements of the GNU Affero General Public License, section 13, concerning interaction through a network will apply to the combination as such.

14. Revised Versions of this License.

The Free Software Foundation may publish revised and/or new versions of the GNU General Public License from time to time. Such new versions will be similar in spirit to the present version, but may differ in detail to address new problems or concerns.

Each version is given a distinguishing version number. If the Program specifies that a certain numbered version of the GNU General Public License “or any later version” applies to it, you have the option of following the terms and conditions either of that numbered version or of any later version published by the Free Software Foundation. If the Program does not specify a version number of the GNU General Public License, you may choose any version ever published by the Free Software Foundation.

If the Program specifies that a proxy can decide which future versions of the GNU General Public License can be used, that proxy’s public statement of acceptance of a version permanently authorizes you to choose that version for the Program.

Later license versions may give you additional or different permissions. However, no additional obligations are imposed on any author or copyright holder as a result of your choosing to follow a later version.

15. Disclaimer of Warranty.

THERE IS NO WARRANTY FOR THE PROGRAM, TO THE EXTENT PERMITTED BY APPLICABLE LAW. EXCEPT WHEN OTHERWISE STATED IN WRITING THE COPYRIGHT HOLDERS AND/OR OTHER PARTIES PROVIDE THE PROGRAM “AS IS” WITHOUT WARRANTY OF ANY KIND, EITHER EXPRESSED OR IMPLIED, INCLUDING, BUT NOT LIMITED TO, THE IMPLIED WARRANTIES OF MERCHANTABILITY AND FITNESS FOR A PARTICULAR PURPOSE. THE ENTIRE RISK AS TO THE QUALITY AND PERFORMANCE OF THE PROGRAM IS WITH YOU. SHOULD THE PROGRAM PROVE DEFECTIVE, YOU ASSUME THE COST OF ALL NECESSARY SERVICING, REPAIR OR CORRECTION.

16. Limitation of Liability.

IN NO EVENT UNLESS REQUIRED BY APPLICABLE LAW OR AGREED TO IN WRITING WILL ANY COPYRIGHT HOLDER, OR ANY OTHER PARTY WHO MODIFIES AND/OR CONVEYS THE PROGRAM AS PERMITTED ABOVE, BE LIABLE TO YOU FOR DAMAGES, INCLUDING ANY GENERAL, SPECIAL, INCIDENTAL OR CONSEQUENTIAL DAMAGES ARISING OUT OF THE USE OR INABILITY TO USE THE PROGRAM (INCLUDING BUT NOT LIMITED TO LOSS OF DATA OR DATA BEING RENDERED INACCURATE OR LOSSES SUSTAINED BY YOU OR THIRD PARTIES OR A FAILURE OF THE PROGRAM TO OPERATE WITH ANY OTHER PROGRAMS), EVEN IF SUCH HOLDER OR OTHER PARTY HAS BEEN ADVISED OF THE POSSIBILITY OF SUCH DAMAGES.

17. Interpretation of Sections 15 and 16.

If the disclaimer of warranty and limitation of liability provided above cannot be given local legal effect according to their terms, reviewing courts shall apply local law that most closely approximates an absolute waiver of all civil liability in connection with the Program, unless a warranty or assumption of liability accompanies a copy of the Program in return for a fee.

END OF TERMS AND CONDITIONS

GNU Lesser General Public License

Version 3, 29 June 2007

Copyright © 2007 Free Software Foundation, Inc. <<http://fsf.org/>>

Everyone is permitted to copy and distribute verbatim copies of this license document, but changing it is not allowed.

This version of the GNU Lesser General Public License incorporates the terms and conditions of version 3 of the GNU General Public License, supplemented by the additional permissions listed below.

0. Additional Definitions.

As used herein, “this License” refers to version 3 of the GNU Lesser General Public License, and the “GNU GPL” refers to version 3 of the GNU General Public License.

“The Library” refers to a covered work governed by this License, other than an Application or a Combined Work as defined below.

An “Application” is any work that makes use of an interface provided by the Library, but which is not otherwise based on the Library. Defining a subclass of a class defined by the Library is deemed a mode of using an interface provided by the Library.

A “Combined Work” is a work produced by combining or linking an Application with the Library. The particular version of the Library with which the Combined Work was made is also called the “Linked Version”.

The “Minimal Corresponding Source” for a Combined Work means the Corresponding Source for the Combined Work, excluding any source code for portions of the Combined Work that, considered in isolation, are based on the Application, and not on the Linked Version.

The “Corresponding Application Code” for a Combined Work means the object code and/or source code for the Application, including any data and utility programs needed for reproducing the Combined Work from the Application, but excluding the System Libraries of the Combined Work.

1. Exception to Section 3 of the GNU GPL.

You may convey a covered work under sections 3 and 4 of this License without being bound by section 3 of the GNU GPL.

2. Conveying Modified Versions.

If you modify a copy of the Library, and, in your modifications, a facility refers to a function or data to be supplied by an Application that uses the facility (other than as an argument passed when the facility is invoked), then you may convey a copy of the modified version:

- a) under this License, provided that you make a good faith effort to ensure that, in the event an Application does not supply the function or data, the facility still operates, and performs whatever part of its purpose remains meaningful, or
- b) under the GNU GPL, with none of the additional permissions of this License applicable to that copy.

3. Object Code Incorporating Material from Library Header Files.

The object code form of an Application may incorporate material from a header file that is part of the Library. You may convey such object code under terms of your choice, provided that, if the incorporated material is not limited to numerical parameters, data structure layouts and accessors, or small macros, inline functions and templates (ten or fewer lines in length), you do both of the following:

- a) Give prominent notice with each copy of the object code that the Library is used in it and that the Library and its use are covered by this License.
- b) Accompany the object code with a copy of the GNU GPL and this license document.

4. Combined Works.

You may convey a Combined Work under terms of your choice that, taken together, effectively do not restrict modification of the portions of the Library contained in the Combined Work and reverse engineering for debugging such modifications, if you also do each of the following:

- a) Give prominent notice with each copy of the Combined Work that the Library is used in it and that the Library and

its use are covered by this License.

- b) Accompany the Combined Work with a copy of the GNU GPL and this license document.
- c) For a Combined Work that displays copyright notices during execution, include the copyright notice for the Library among these notices, as well as a reference directing the user to the copies of the GNU GPL and this license document.
- d) Do one of the following:
 - 0) Convey the Minimal Corresponding Source under the terms of this License, and the Corresponding Application Code in a form suitable for, and under terms that permit, the user to recombine or relink the Application with a modified version of the Linked Version to produce a modified Combined Work, in the manner specified by section 6 of the GNU GPL for conveying Corresponding Source.
 - 1) Use a suitable shared library mechanism for linking with the Library. A suitable mechanism is one that (a) uses at run time a copy of the Library already present on the user's computer system, and (b) will operate properly with a modified version of the Library that is interface-compatible with the Linked Version.
- e) Provide Installation Information, but only if you would otherwise be required to provide such information under section 6 of the GNU GPL, and only to the extent that such information is necessary to install and execute a modified version of the Combined Work produced by recombining or relinking the Application with a modified version of the Linked Version. (If you use option 4d0, the Installation Information must accompany the Minimal Corresponding Source and Corresponding Application Code. If you use option 4d1, you must provide the Installation Information in the manner specified by section 6 of the GNU GPL for conveying Corresponding Source.)

5. Combined Libraries.

You may place library facilities that are a work based on the Library side by side in a single library together with other library facilities that are not Applications and are not covered by this License, and convey such a combined library under terms of your choice, if you do both of the following:

- a) Accompany the combined library with a copy of the same work based on the Library, uncombined with any other library facilities, conveyed under the terms of this License.
- b) Give prominent notice with the combined library that part of it is a work based on the Library, and explaining where to find the accompanying uncombined form of the same work.

6. Revised Versions of the GNU Lesser General Public License.

The Free Software Foundation may publish revised and/or new versions of the GNU Lesser General Public License from time to time. Such new versions will be similar in spirit to the present version, but may differ in detail to address new problems or concerns.

Each version is given a distinguishing version number. If the Library as you received it specifies that a certain numbered version of the GNU Lesser General Public License “or any later version” applies to it, you have the option of following the terms and conditions either of that published version or of any later version published by the Free Software Foundation. If the Library as you received it does not specify a version number of the GNU Lesser General Public License, you may choose any version of the GNU Lesser General Public License ever published by the Free Software Foundation.

If the Library as you received it specifies that a proxy can decide whether future versions of the GNU Lesser General Public License shall apply, that proxy's public statement of acceptance of any version is permanent authorization for you to choose that version for the Library.

OpenSSL License

Copyright (c) 1998-2017 The OpenSSL Project. All rights reserved.

Redistribution and use in source and binary forms, with or without modification, are permitted provided that the following conditions are met:

1. Redistributions of source code must retain the above copyright notice, this list of conditions and the following disclaimer.
2. Redistributions in binary form must reproduce the above copyright notice, this list of conditions and the following disclaimer in the documentation and/or other materials provided with the distribution.
3. All advertising materials mentioning features or use of this software must display the following acknowledgment: "This product includes software developed by the OpenSSL Project for use in the OpenSSL Toolkit. (<http://www.openssl.org/>)"
4. The names "OpenSSL Toolkit" and "OpenSSL Project" must not be used to endorse or promote products derived from this software without prior written permission. For written permission, please contact openssl-core@openssl.org.
5. Products derived from this software may not be called "OpenSSL" nor may "OpenSSL" appear in their names without prior written permission of the OpenSSL Project.
6. Redistributions of any form whatsoever must retain the following acknowledgment: "This product includes software developed by the OpenSSL Project for use in the OpenSSL Toolkit (<http://www.openssl.org/>)"

THIS SOFTWARE IS PROVIDED BY THE OpenSSL PROJECT ``AS IS'' AND ANY EXPRESSED OR IMPLIED WARRANTIES, INCLUDING, BUT NOT LIMITED TO, THE IMPLIED WARRANTIES OF MERCHANTABILITY AND FITNESS FOR A PARTICULAR PURPOSE ARE DISCLAIMED. IN NO EVENT SHALL THE OpenSSL PROJECT OR ITS CONTRIBUTORS BE LIABLE FOR ANY DIRECT, INDIRECT, INCIDENTAL, SPECIAL, EXEMPLARY, OR CONSEQUENTIAL DAMAGES (INCLUDING, BUT NOT LIMITED TO, PROCUREMENT OF SUBSTITUTE GOODS OR SERVICES; LOSS OF USE, DATA, OR PROFITS; OR BUSINESS INTERRUPTION) HOWEVER CAUSED AND ON ANY THEORY OF LIABILITY, WHETHER IN CONTRACT, STRICT LIABILITY, OR TORT (INCLUDING NEGLIGENCE OR OTHERWISE) ARISING IN ANY WAY OUT OF THE USE OF THIS SOFTWARE, EVEN IF ADVISED OF THE POSSIBILITY OF SUCH DAMAGE.

This product includes cryptographic software written by Eric Young (eay@cryptsoft.com). This product includes software written by Tim Hudson (tjh@cryptsoft.com).

Original SSLeay License

Copyright (C) 1995-1998 Eric Young (eay@cryptsoft.com) All rights reserved.

This package is an SSL implementation written by Eric Young (eay@cryptsoft.com). The implementation was written so as to conform with Netscapes SSL.

This library is free for commercial and non-commercial use as long as the following conditions are adhered to. The following conditions apply to all code found in this distribution, be it the RC4, RSA, lhash, DES, etc., code; not just the SSL code. The SSL documentation included with this distribution is covered by the same copyright terms except that the holder is Tim Hudson (tjh@cryptsoft.com).

Copyright remains Eric Young's, and as such any Copyright notices in the code are not to be removed. If this package is used in a product, Eric Young should be given attribution as the author of the parts of the library used. This can be in the form of a textual message at program startup or in documentation (online or textual) provided with the package.

Redistribution and use in source and binary forms, with or without modification, are permitted provided that the following conditions are met:

1. Redistributions of source code must retain the copyright notice, this list of conditions and the following disclaimer.
2. Redistributions in binary form must reproduce the above copyright notice, this list of conditions and the following disclaimer in the documentation and/or other materials provided with the distribution.
3. All advertising materials mentioning features or use of this software must display the following acknowledgement: "This product includes cryptographic software written by Eric Young (eay@cryptsoft.com)" The word 'cryptographic' can be left out if the routines from the library being used are not cryptographic related :-).
4. If you include any Windows specific code (or a derivative thereof) from the apps directory (application code) you must include an acknowledgement: "This product includes software written by Tim Hudson (tjh@cryptsoft.com)"

THIS SOFTWARE IS PROVIDED BY ERIC YOUNG ``AS IS'' AND ANY EXPRESS OR IMPLIED WARRANTIES, INCLUDING, BUT NOT LIMITED TO, THE IMPLIED WARRANTIES OF MERCHANTABILITY AND FITNESS FOR A PARTICULAR PURPOSE ARE DISCLAIMED. IN NO EVENT SHALL THE AUTHOR OR CONTRIBUTORS BE LIABLE FOR ANY DIRECT, INDIRECT, INCIDENTAL, SPECIAL, EXEMPLARY, OR CONSEQUENTIAL DAMAGES (INCLUDING, BUT NOT LIMITED TO, PROCUREMENT OF SUBSTITUTE GOODS OR SERVICES; LOSS OF USE, DATA, OR PROFITS; OR BUSINESS INTERRUPTION) HOWEVER CAUSED AND ON ANY THEORY OF LIABILITY, WHETHER IN CONTRACT, STRICT LIABILITY, OR TORT (INCLUDING NEGLIGENCE OR OTHERWISE) ARISING IN ANY WAY OUT OF THE USE OF THIS SOFTWARE, EVEN IF ADVISED OF THE POSSIBILITY OF SUCH DAMAGE.

The licence and distribution terms for any publically available version or derivative of this code cannot be changed. i.e. this code cannot simply be copied and put under another distribution licence [including the GNU Public Licence.]

Suprema
SECURITY & BIOMETRICS

(주) 슈프리마

13554 경기도 성남시 분당구 정자일로 248 파크뷰타워 17층

영업 문의 1522 4507(1번) korea@suprema.co.kr | 고객센터 1522 4507(2번) cs@suprema.co.kr