

FaceStation 2

USER GUIDE

Version 1.14
English

EN 102.00.FS2 V1.14A

Contents

Safety Instructions	4
Introduction	6
Components	6
Name and function of each part.....	7
Cables and connectors	9
Correct face registration and authentication method.....	10
Cautions for registering a face.....	10
Cautions for authenticating a face	10
Admin Menu.....	11
All Menus.....	11
User	12
Registering user information.....	12
Modifying user information.....	14
Delete All Users	14
View User Usage	14
Authentication	15
Auth Mode	15
Modifying Auth Mode	15
Delete Auth Mode	16
Add Auth Mode.....	16
Operation	16
Face Recognition	17
T&A Mode	17
Network	18
Network Settings.....	18
Ethernet	18
Wireless.....	19
Server.....	19
Serial Settings	20
RS-485.....	20
Display & Sound.....	21
Device	22
Interphone.....	22
Relay	22
Date & Time	22
Daylight Saving Time	23
Device Info.....	23
Memory Info	23
USB Memory.....	23
Secure Tamper	24
Restart Device	24
Restore Default.....	24
User ID Type.....	25

Event Log 26
 Search Log26
 Detail View Log.....26
 Delete All Logs.....26
 View Log Usage27

Troubleshooting 28
 Checklist before reporting a failure28

Product specifications..... 29
 Dimensions.....30

FCC compliance information 31

EU Declaration of Conformity (CE) 31

Appendices..... 32
 Disclaimers32
 Copyright notice.....32
 Open Source License32
 GNU General Public License.....32
 OpenSSL License.....38
 Original SSLeay License39

Safety Instructions

Observe the following instructions to use the product safely and prevent any risk of injury or property damage.

Warning

Noncompliance with instructions can lead to serious injury or death.

Installation

Do not install the product in a location with direct sunlight, moisture, dust, or soot.

- Fire or electric shock may occur.

Do not install the product in a location with heat from an electric heater.

- Fire or electric shock may occur due to overheating.

Install the product in a dry location.

- Otherwise, product damage or electric shock may occur due to moisture.

Install the product in a location with no electromagnetic interference.

- Otherwise, product damage or electric shock may occur.

The user should not install or repair the product independently.

- Fire, electric shock, or personal injury may occur.
- If the product has been damaged due to independent installation or repair of the product by the user, free A/S service will not be provided.

Operation

Do not allow liquids such as water, beverages, or chemicals get into the product.

- Fire, electric shock, or product damage may occur.

Caution

Noncompliance of instructions could lead to minor injury or product damage.

Installation

Do not install the power supply cable in a location where people pass by.

- Product damage or physical injury may occur.

Do not install the product near a highly magnetic object such as a magnet, TV, monitor (especially CRT), or speaker.

- Product failure may occur.

Use only a D.C 24 V and 2.5 A or higher power supply adaptor.

- If the proper power supply is not used, the product may not operate properly.

Use a separate power supply for the Secure I/O 2, electric lock, and FaceStation 2, respectively.

- If connecting and using the power supply to these devices together, the devices may malfunction.

Keep the minimum separation distances between the devices when install multiple devices.

- Otherwise, RF performance is affect to the other device, the devices may not operate normally.

Operation

Do not drop the product or apply an impact to the product.

- Product failure may occur.

Manage the password with care; do not to disclose it to others and change it periodically.

- Otherwise, illegal intrusion may occur.

Do not press the buttons on the product forcibly or using a sharp tool.

- Product failure may occur.

When cleaning the product, wipe the product with a soft and dry cloth. Do not apply water, benzene, or alcohol.

- These may cause product failure.

FaceStation 2 uses a capacitive screen and buttons. If the environment is moist from wet weather, or the product surface is smeared with a large amount of water, wipe the product off with a dry towel before using it.

RTC battery

Replacing the battery with an incorrect type of battery may cause explosion.

Discard the battery according to appropriate regional or international waste regulations.

Introduction

Components

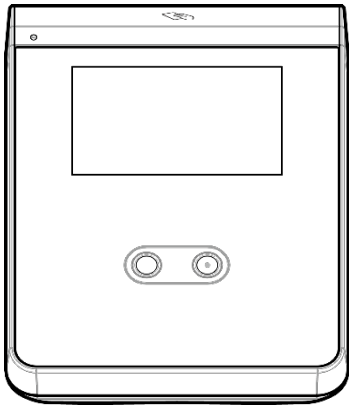

FaceStation 2

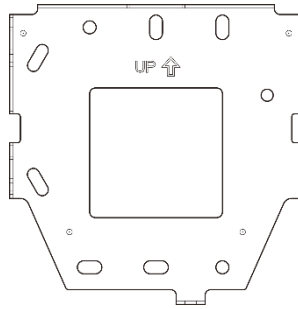

Wall Bracket

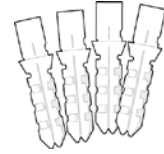

PVC Anchor x4

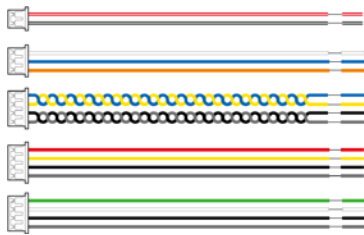
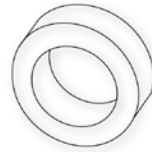
Bracket Fixing Screw
(Star Shaped)Connection Cable
(1x2-pin, 1x3-pin, 3x4-pin)

Ferrite Core

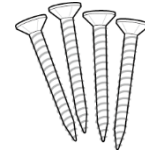

Fixing Screw x4

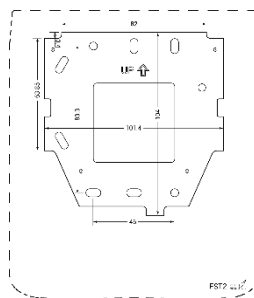

Diode

120 Ω resistor

Drilling Template

Open Source Software
Guide

Quick Guide

NOTE

- Components may vary according to the installation environment.
- For additional content regarding product installation, visit the Suprema website (www.suprema.co.kr) and view the installation guide.

Name and function of each part

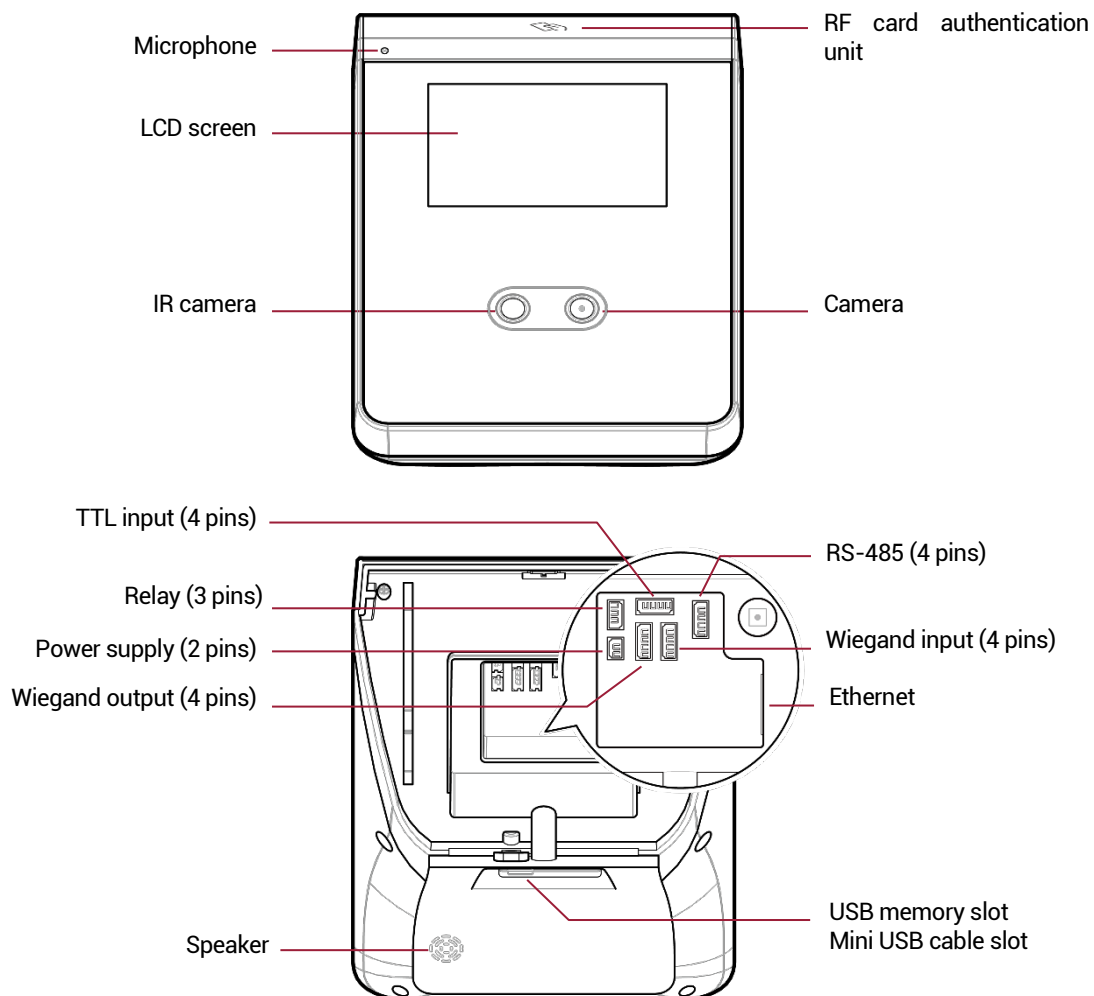

Name	Description
Microphone	Delivers the voice of the user when the interphone is connected.
LCD screen	Provides UI for operation.
IR camera	Captures IR images.
Camera	Captures actual images.
RF card authentication unit	Scans the card for entrance.
Speaker	Delivers sound.
USB memory slot	Connects USB memory.
Mini USB cable slot	Will be supported in the future.
TTL input (4 pins)	Connects the TTL input cable.
RS-485 (4 pins)	Connects the RS-485 cable.
Relay (3 pins)	Connects the relay cable.

Power supply (2 pins)	Connects the power supply cable.
Ethernet	Connects the Ethernet cable.
Wiegand input (4 pins)	Connects the Wiegand input cable.
Wiegand output (4 pins)	Connects the Wiegand output cable.

Cables and connectors

Power



Pin	Name	Color
1	PWR +VDC	Red (White stripe)
2	PWR GND	Black (White stripe)

Relay



Pin	Name	Color
1	RLY NO	White
2	RLY COM	Blue
3	RLY NC	Orange

RS-485



Pin	Name	Color
1	485 TRXP	Blue
2	485 TRXN	Yellow
3	485 GND	Black
4	SH GND	Gray

TTL input



Pin	Name	Color
1	TTL IN0	Red
2	TTL IN1	Yellow
3	TTL GND	Black
4	SH GND	Gray

Wiegand input and output



Pin	Name	Color
1	WG D0	Green
2	WG D1	White
3	WG GND	Black
4	SH GND	Gray

Correct face registration and authentication method

Cautions for registering a face

- When registering a face, maintain a distance of 40cm to 80cm between the device and the face.
- Be careful not to change the facial expression. (smiling face, drawn face, wink, etc.)
- If you do not follow the instructions on the screen, the face registration may take longer or may fail.
- Be careful not to cover the eyes or eyebrows.
- Do not wear hats, masks, sunglasses or eyeglasses.
- Be careful not to display two faces on the screen. Register one person at a time.
- It is recommended for a user wearing glasses to register both faces with and without glasses.

Cautions for authenticating a face

- Ensure that the face appears inside the guideline displayed on the screen of the device.
- If glasses have been changed, authentication may fail. If the face without glasses has been registered, authenticate the face without glasses. If only the face with glasses has been registered, authenticate the face with the previously worn glasses again.
- If a part of the face is covered with a hat, a mask, an eye patch, or sunglasses authentication may fail. Do not cover the face; allow the device to recognize both the eyebrows and the face.

Admin Menu

All Menus

- 1 Press  and authenticate with the Admin level credential.
- 2 Select the desired menu.

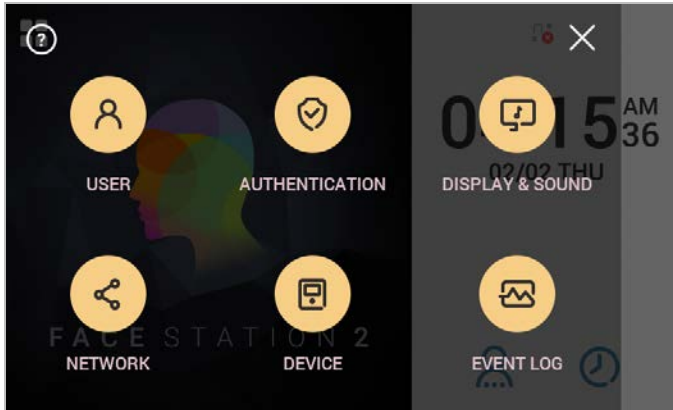



NOTE

- If the administrator has not been designated, the menu screen will be displayed when you press .

User

Registering user information

The user information, including the face, can be registered.

- 1 Press  and authenticate with the Admin level credential.
- 2 Press **User** > . The face registration wizard will begin.

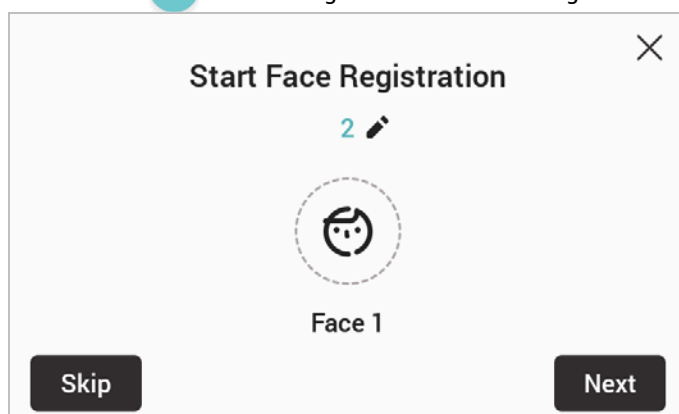

- 3 To proceed with the face registration wizard, press **Next**. To skip, press **Skip** and go to step 5.
- 4 If you have pressed **Next**, register the face according to the instructions on the screen. Face registration is carried out in 3 steps.

(1) Registering the front face



(2) Moving the face up and down



(3) Moving the face to the left and right





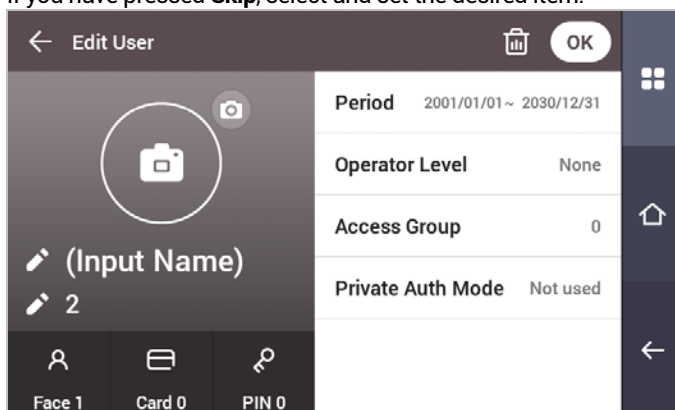

When the face registration wizard is used, only the user's face is registered. Modify other information by pressing **Edit** after registering the face.

NOTE

- When registering a face, maintain a distance of 40cm to 80cm between the device and the face.
- Be careful not to change the facial expression. (smiling face, drawn face, wink, etc.)
- If you do not follow the instructions on the screen, the face registration may take longer or may fail.
- Be careful not to cover the eyes or eyebrows.
- Do not wear hats, masks, sunglasses or eyeglasses.
- Be careful not to display two faces on the screen. Register one person at a time.
- It is recommended for a user wearing glasses to register both faces with and without glasses.

5 If you have pressed **Skip**, select and set the desired item.

-  Take a picture of a user with the built-in camera.
- **Name:** Enter the user name.
- **ID:** Enter a number between 1 and 429467295 to register as the user ID. If **User ID Type** set to **Alphanumeric**, a combination of alphanumeric characters and symbols (., -) can be used for the ID. Up to 32 characters can be input.
- **Face:** Register a face for user authentication. Press  and register a face according to the instructions on the screen. To register another face, press  again.
- **Card:** Register a card for user authentication. Press  and scan the card that will be assigned to the user. To register an additional card, press  again.
- **PIN:** Enter the PIN you wish to use. Enter the PIN you wish to use, and then reenter the same PIN for confirmation. Enter a number between 4 and 16 digits to prevent leaking.
- **Validity period:** Set a Start Date and End Date to use the user account. When you press the first date, you can set **Start Date**, and when you press the second date, you can set **End Date**.
- **Operator Level:** Select the level you wish to assign to a user.
- **Face Group:** Select a face group for the user. Face groups can be used only when **Group Matching** is enabled, and these groups can be registered only in BioStar 2.
- **Access Group:** Check an access group for the user. Access groups can only be registered in BioStar 2.
- **Private Auth Mode:** Change the authentication method according to the user.

NOTE



Available menus vary according to the set operator level.

- **None:** This is the general user level; menus cannot be accessed.
- **Full Administrator:** All menus can be accessed.
- **Configuration:** **AUTHENTICATION, DISPLAY & SOUND, DEVICE, NETWORK** and **EVENT LOG** menus can be accessed.
- **User Management:** **USER** and **EVENT LOG** menu can be accessed.
-

6 When you press **OK**, settings will be saved.

Modifying user information

User Management or Administrator can modify the registered user information. A user's face or card can be added, and the PIN and level can be modified.



- 1 Press  and authenticate with the Admin level credential.
- 2 Press **User** > .
- 3 Select your search terms. You can search for a user by **User ID, Name, Face** and **Card**.
- 4 Select a user you wish to modify and modify the information by referring to **Registering user information**.
 - To select a user, press  and then press **OK**.

NOTE

- **Access Group** can be registered in BioStar 2. For detailed contents regarding registering an access group, refer to the BioStar 2 Administrator Manual.



Delete All Users

You can delete all registered users at once.

- 1 Press  and authenticate with the Admin level credential.
- 2 Press **User** >  and select **Delete All** or select a user you wish to delete.
- 3 When you press **OK**, all registered users will be deleted.

View User Usage

You can see the number of registered users, faces, and cards at a glance.

- 1 Press  and authenticate with the Admin level credential.
- 2 Press **User** > .

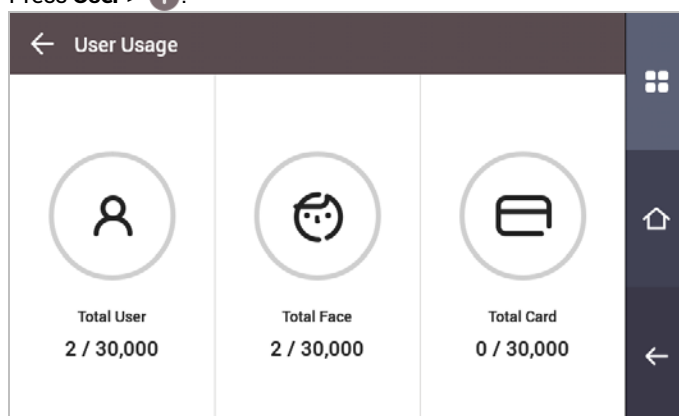





Authentication

Auth Mode







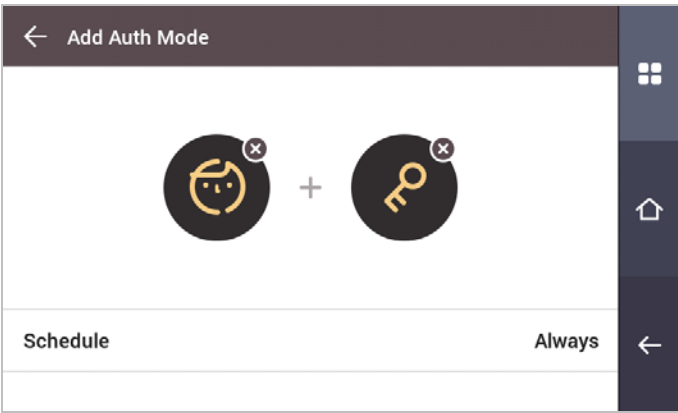



Modifying Auth Mode

You can set the authentication method and schedule according to each credential.

- 1 Press  and authenticate with the Admin level credential.
- 2 Press **AUTHENTICATION > Auth Mode**.
- 3 Press  to add an auth mode or press an auth mode you wish to modify.
- 4 Pressing the  icon will delete the selected credential, and pressing  will display an addable credential on the screen.



- 5 Set the desired auth mode and select a schedule.



Classification	Description
Face	<ul style="list-style-type: none"> • : Mode allowing authentication with a face only. • : Mode to authenticate with a face and PIN.
Card	<ul style="list-style-type: none"> • : Mode allowing authentication with a card only • : Mode allowing authentication with a card and then with a face. • : Mode allowing authentication with a card and PIN. • : Mode allowing authentication with a card and then with a face or PIN. • : Mode allowing authentication with a card and then with both a face and PIN input.
ID	<ul style="list-style-type: none"> • : Mode allowing authentication by entering ID and then authenticating the face. • : Mode allowing authentication by entering ID and then a PIN. • : Mode allowing authentication by entering ID and then authenticating the face or entering a PIN. • : Mode allowing authentication by entering ID and then using both face authentication and PIN input.

- 6 When you press **OK**, settings will be saved.



NOTE

- A schedule can be set in BioStar 2. If there is no set schedule, only **Always** can be selected.
- For detailed contents regarding setting a schedule, refer to BioStar 2 Administrator's manual.

Delete Auth Mode

- 1 Press  and authenticate with the Admin level credential.
- 2 Press **AUTHENTICATION > Auth Mode**.
- 3 Press  and select an item to delete.
- 4 When you press **OK**, the selected item will be deleted.

Add Auth Mode

- 1 Press  and authenticate with the Admin level credential.
- 2 Press **AUTHENTICATION > Auth Mode**.
- 3 Press .
- 4 Set the desired auth mode by pressing , then select a schedule.
- 5 When you press **OK**, the auth mode will be added.

Operation

- 1 Press  and authenticate with the Admin level credential.
- 2 Press **AUTHENTICATION** and then modify the items below **Operation**.

Operation			
Ambient Brightness	Normal	Face Pose Variation	4
Motion Sensor	Medium	Enroll Timeout	60 Sec
Auth Timeout			5 Sec

- **Ambient Brightness:** Detect the ambient brightness and adjust the intensity of IR LED. Change settings according to the installation environment.
- **Motion Sensor:** Set the sensitivity for detecting motion near the device.
- **Auth Timeout:** If the authentication is not completed during the set time, the authentication will fail.
- **Face Pose Variation:** Set the sensitivity for the position, angle, and distance of a face when registering the face. Set high if you wish to obtain a detailed face template
- **Enroll Timeout:** If a face is not registered during the set time, the face registration will be canceled.

Face Recognition

Change settings regarding face authentication.

- 1 Press  and authenticate with the Admin level credential.
- 2 Press **AUTHENTICATION** and then modify the items below **Face Recognition**.

Face Recognition			
Security Level	Normal	Group Matching	<input type="checkbox"/>
Backward Compatibility (Enrollment in v1.0.1)			<input type="checkbox"/>
Enhanced fake face enrollment block		Disabled	

- **Security Level:** Set the security level for 1:N authentication.
- **Group Matching:** Check whether or not to use Group Matching. If Group Matching is used, you can increase the authentication speed by designing various user's faces in a group.
- **Backward Compatibility (Enrollment in v1.0.1):** Turn on this option if the firmware of the device that enrolled the face template is v1.0.1 or older.
- **Enhanced fake face enrollment block:** You can detect user enrollment using fake faces such as photos. The strength can be set from Level 1 to Level 3. The higher the level, the stronger the level of detection.

NOTE

- **Group Matching** can be set in BioStar 2. For detailed contents, refer to the BioStar 2 Administrator Manual.
- If you set **Enhanced fake face enrollment block** to high level, the enrollment of real face may be rejected. If you fail to enroll, try again or lower your detection strength.

T&A Mode

You can set how to register T&A Mode.

- 1 Press  and authenticate with the Admin level credential.
- 2 Press **AUTHENTICATION** then modify the items below **T&A Mode**.

T&A Mode			
T&A Mode	By User	T&A Code	0
T&A Required	<input type="checkbox"/>	Job Code	<input type="checkbox"/>

- 3 Select and set the desired item.
 - **T&A Mode:** Set the method to use T&A mode.
 - **T&A Code:** Register a new T&A code.
 - **T&A Required:** Set to require a user to select a T&A event when authenticating.
 - **Job Code:** Select whether or not to use Job Code.

Network

Network Settings

You can change the network settings of the device.

Ethernet

1 Press  and authenticate with the Admin level credential.

2 Press **NETWORK > Ethernet**.

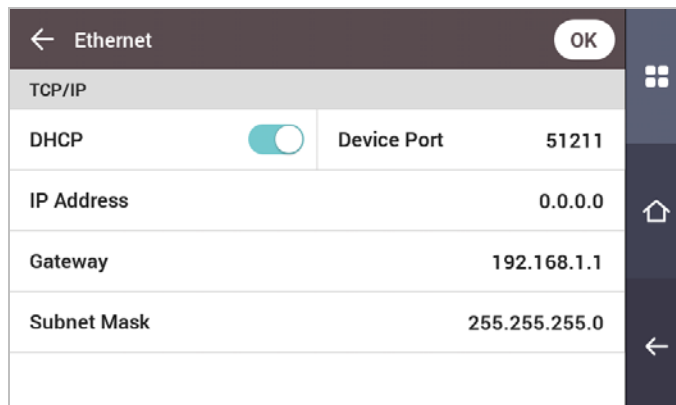

TCP/IP	
DHCP	Device Port 51211
IP Address	0.0.0.0
Gateway	192.168.1.1
Subnet Mask	255.255.255.0

- **DHCP:** Set whether or not to use DHCP. If DHCP setting is disabled, the user can modify **Device Port, IP Address, Gateway, Subnet Mask, and DNS**.
- **Device Port:** Set the device port.
- **IP Address:** View the IP address of the device. To modify, disable DHCP setting.
- **Gateway:** View the gateway of the device. To modify, disable DHCP setting.
- **Subnet Mask:** View the subnet mask of the device. To modify, disable DHCP setting.
- **DNS server:** Set the DNS server address.

3 To modify network information manually, disable DHCP setting. You can modify **Device Port, IP Address, Gateway, Subnet Mask** and **DNS**.

NOTE

- **Ethernet** cannot be used at the same time as **Wireless**.

Wireless

- 1 Press  and authenticate with the Admin level credential.
- 2 Press **NETWORK > Wireless**.
- 3 The list of available networks for connection will be displayed.

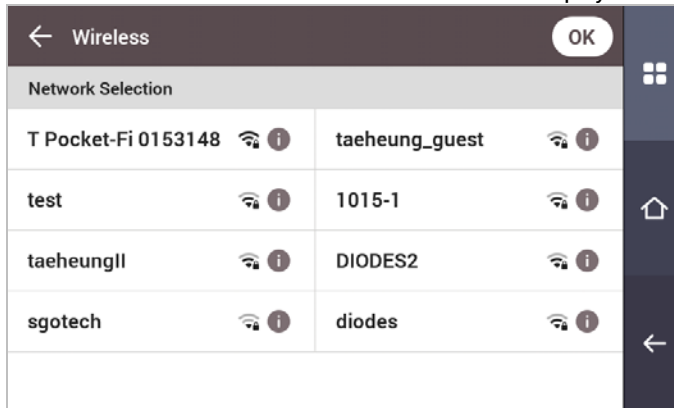

- 4 Select the network to which you wish to connect and enter the password. When you press **OK**, the connection to the wireless network will be made.
- 5 To set the network information of the wireless LAN manually, press  of the network name you wish to use and disable DHCP setting. You can modify **IP Address, Gateway, Subnet Mask** and **DNS**.

NOTE

- **Wireless** cannot be used at the same time as **Ethernet**.
- To connect to **Wireless**, a wireless router is required. For content regarding the installation and configuration of a wireless router, refer to the user manual of the wireless router.

Server

- 1 Press  and authenticate with the Admin level credential.
- 2 Press **NETWORK > Server**.



- **Connection Mode:** When you select **Device -> Server**, you can send a connection signal from the device to a server with the input information directly. When you select **Server -> Device**, **Server IP**, **Server URL** and **Server Port** cannot be entered.
- **Server IP:** Enter the IP address of the PC on which BioStar 2 is installed. Input is accepted only when **Device -> Server** is set for **Connection Mode**.
- **Server URL:** Enter server URL instead of **Server IP**. Input is accepted only when **Device -> Server** is set for **Connection Mode**.
- **Server Port:** Enter the port of the PC on which BioStar 2 is installed. Input is accepted only when **Device -> Server** is set for **Connection Mode**.

Serial Settings

RS-485

- 1 Press  and authenticate with the Admin level credential.
- 2 Press **NETWORK** and then modify the items below **Serial Setting**.

Serial Setting			
RS-485	Default	Baud Rate	115200

- **RS-485:** Select the RS-485 mode.
- **Baud Rate:** Select the desired baud rate.

Display & Sound

You can change the display and sound settings of the device.

- 1 Press  and authenticate with the Admin level credential.
- 2 Press **DISPLAY & SOUND**.
- 3 Change the desired item.

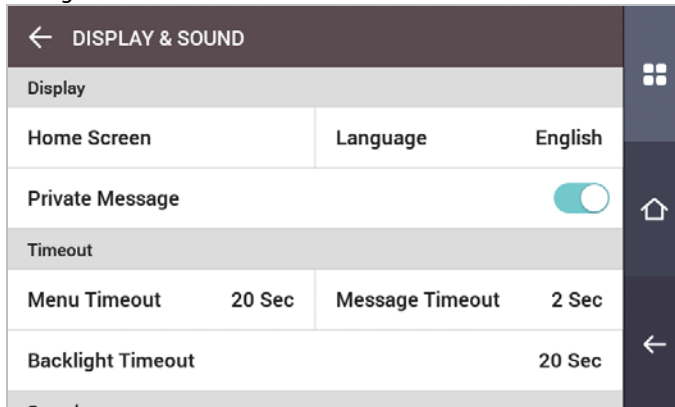

- **Home Screen:** Select items to be displayed in the background of the home screen. When **Custom** is selected for **Style**, the user can modify the Home Screen directly. Edit the Home Screen by pressing and holding the desired object, then dragging and dropping it to a desired location.

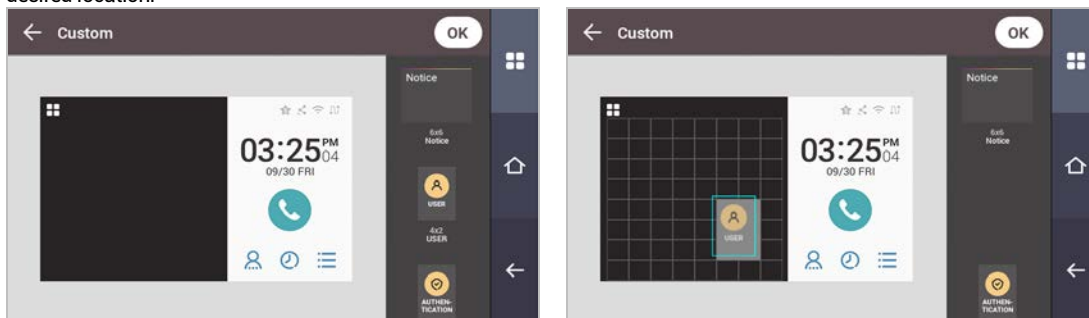

- **Language:** Set the language you wish to use.
- **Private Message:** Set whether or not to use a Private Message, which will be displayed on the screen when the user authenticates.
- **Menu Timeout:** Set the time (in seconds) for the menu screen to disappear automatically. If there is no button input during a set time, the screen will return to the home screen.
- **Message Timeout:** Set the time (in seconds) for a setting complete message or information message to disappear automatically.
- **Backlight Timeout:** Set the time (in seconds) to automatically turn off the lighting of the LCD screen.
- **Voice Instruction:** Set to use the voice instruction instead of alarm sounds.
- **Volume:** Set the volume.

Device

Interphone

Set the account and extensions of SIP interphone.

- 1 Press  and authenticate with the Admin level credential.
- 2 Press **DEVICE > Interphone**.
- 3 When Enable is set for Interphone, you can set the SIP account and the extensions. Ensure to set each item correctly.

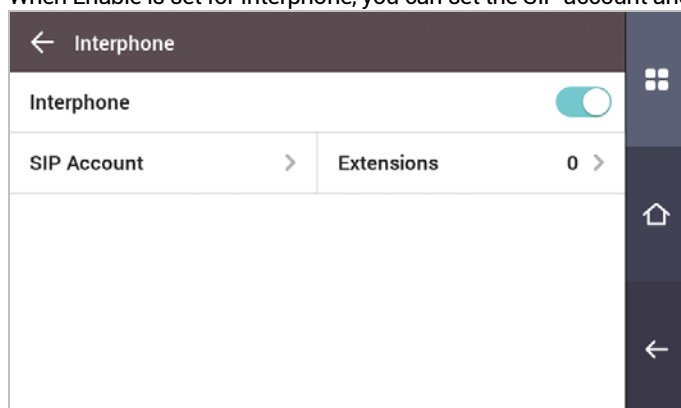

Relay

You can set the open time and the input port of the exit button in the device.

- 1 Press  and authenticate with the Admin level credential.
- 2 Press **DEVICE > Relay**.
 - **Open Time**: Set the duration for the door to remain open when standard user authentication has been carried out.
 - **Exit button**: Select the input port where the exit button is connected.
 - **Switch**: Select the relay type (N/O or N/C).

Date & Time

You can set date and time. Set the date and time accurately in order to collect accurate log data.

- 1 Press  and authenticate with the Admin level credential.
- 2 Press **DEVICE > Date & Time**.
- 3 Change the desired item.

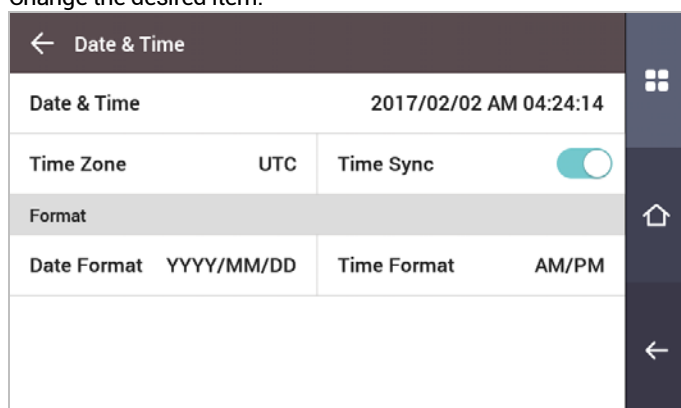

- **Date & Time**: Check the current date and time. To modify it directly, disable **Time Sync**.
- **Standard time zone**: Set the time reference of the current location.

- **Time Sync:** Synchronize the server and the time. If you wish to synchronize the server and the time, enable Time Sync.
- **Date Format:** Set the date format. You can select among **YYYY/MM/DD**, **MM/DD/YYYY** and **DD/MM/YYYY**.
- **Time Format:** Set the time format. You can select either **24-Hour** or **AM/PM**.

Daylight Saving Time

You can use the device by applying daylight saving time. Set the start and end time correctly.

- 1 Press  and authenticate with the Admin level credential.
- 2 Press **DEVICE > Daylight Saving Time**.
- 3 Select the desired item and change the setting.

Device Info

You can view the model name, firmware version of Device ID, and MAC address.

- 1 Press  and authenticate with the Admin level credential.
- 2 Press **DEVICE > Device Info**.
- 3 You can view the information including **Model Name**, **Device ID**, **HW**, **FW**, **Kernel**, **MAC**, and **WiFi MAC**.

Memory Info

View the status of memory usage.

- 1 Press  and authenticate with the Admin level credential.
- 2 Press **DEVICE > Memory Info**.

USB Memory

Connect USB Memory and import user information to the device or export log and user information from the device. Upgrade the firmware.

- 1 Press  and authenticate with the Admin level credential.
- 2 Press **DEVICE > USB Memory**.
- 3 Select the desired item and change the setting.
 - **Import:** Import user information from the connected USB memory.
 - **Export:** Select information you wish to export to the connected USB memory.
 - **FW Upgrade:** Upgrade the firmware if the firmware files are saved in the connected USB memory.

NOTE

The type of supported USB memory is as follows. If you use a different type of USB memory, the function may not operate normally.

- Samsung Electronics: SUM-LSB 8GB, SUM-PSB 8GB, SUM-PSB 16GB, SUM-BSG 32GB
- LG Electronics: XTICK J3 WINDY 8GB, SMART USB MU1 White 8GB, MU 1 USB 32GB, MU28GBC 32GB, XTICK MOBY J1 16GB
- SanDisk: Cruzer 16GB, Cruzer Blade CZ50 4GB, Cruzer Blade CZ50 32GB, CZ48 Ultra USB 3.0 64GB, CZ80 USB3.0 64GB, CZ52 64GB, Cruzer Glide Z60 128GB, Cruzer Force CZ71 32GB
- Sony: Micro Vault Click 8GB, MicroVault CLICK 16GB, USM-SA1 32GB
- Transcend: JetFlash 760 8GB, JetFlash 760 32GB, JetFlash 500 8GB
- Memorette: MINI500 8GB
- A-DATA: S102 PRO 8GB
- Trigem Pastel 8GB

Secure Tamper

When the tamper is turned on, you can set to delete the entire user, the entire log, and the security key.

- 1 Press  and authenticate with the Admin level credential.
- 2 Select **DEVICE > Secure Tamper**, then change the settings.

Restart Device

The user can restart the device.

- 1 Press  and authenticate with the Admin level credential.
- 2 Press **DEVICE > Restart Device**.
- 3 To restart the device, press **OK**. To cancel, press **Cancel**.

Restore Default

Device settings, network settings, and operator levels will be reset.

- 1 Press  and authenticate with the Admin level credential.
- 2 Press **DEVICE > Restore Default**.
 - **All settings**: You can reset all settings stored on the device. Press **OK** to reset all device settings.
 - **Keep Network Settings**: You can reset all settings except network settings. Press **OK** to reset all settings except network settings.
 - **Factory Default**: You can delete all the information saved in the device and the root certificate and restore default settings.
 - **Delete the Root Certificate**: You can delete the root certificate saved in the device.
- 3 If you proceed to restore the defaults, the device will restart.

NOTE

- When you reset, the operator level will be reset as well. After resetting, make sure to set the operator level again.
- Language setting will not change after resetting.
- **Factory Default** menu can be used when the root certificate is saved in the device.
- **Delete the Root Certificate** menu can be used only when the root certificate is saved in the device and Administrator has been designated.

User ID Type

You can set the type of user ID to be registered on the device to a combination of alphabetic characters, numbers, and symbols (⌘ -).

- 1 Press  and authenticate with the Admin level credential.
- 2 Press **DEVICE > User ID Type**.

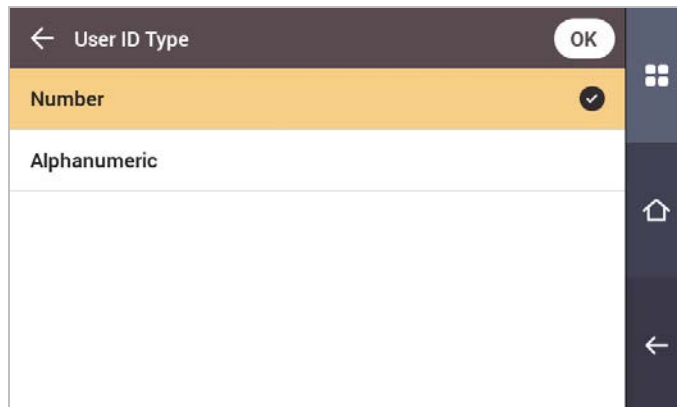



- 3 Change to the desired item and press **OK**.

Event Log

Search Log

You can set a condition and search a log.

- 1 Press  and authenticate with the Admin level credential.
- 2 Press **EVENT LOG**.
- 3 Press  and change the condition. When you press **OK**, a log that matches the condition will be displayed on the screen.





← Search		OK
Date & Time	2001/01/01 00:00~2030/12/31 23:59	
Event	All	
T&A Event	All	
User ID	Input ID	
		

Detail View Log

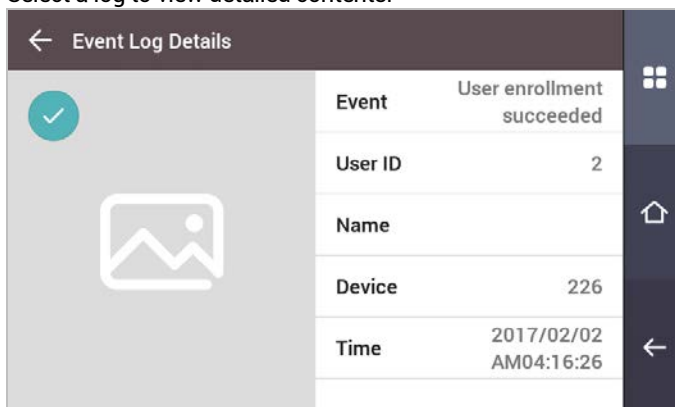

- 1 Press  and authenticate with the Admin level credential.
- 2 Press **EVENT LOG**.
- 3 Select a log to view detailed contents.



← Event Log Details	
	Event User enrollment succeeded
	User ID 2
	Name
	Device 226
	Time 2017/02/02 AM04:16:26



Delete All Logs

You can delete all saved logs.

- 1 Press  and authenticate with the Admin level credential.
- 2 Press **EVENT LOG**.
- 3 To delete all logs, press  and then press **OK**. To cancel, press **Cancel**.

View Log Usage

You can check the status of log usage.

- 1 Press  and authenticate with the Admin level credential.
- 2 Press **EVENT LOG**.
- 3 Press .

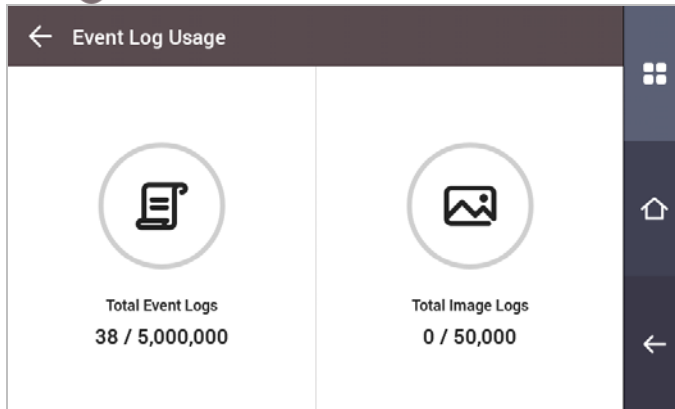

Troubleshooting

Checklist before reporting a failure

Classification	Problem	Solution
Power	The power is being supplied but the device does not operate.	<ul style="list-style-type: none"> • If the distance between the terminal and the bracket is too great, the device may not operate due to the temper switch. • Check the adaptor or the power cable.
PIN	I forgot my PIN.	<ul style="list-style-type: none"> • For a normal user PIN, request it from the administrator and reenter the PIN. • If you have lost the Admin PIN, contact the installation company.
	I entered my PIN and pressed the OK button, but I still cannot open the door.	<ul style="list-style-type: none"> • Check if you entered the registered PIN correctly. • Check if you have changed your PIN recently. • If you cannot remember the PIN, request it from the administrator and reenter the PIN.
Face	The face has been registered but face authentication cannot be done smoothly, and errors occur frequently.	<ul style="list-style-type: none"> • Check 'Cautions for registering a face' and register the face again. • If there are a large number of registered faces, change Matching Timeout and try again.
	Face authentication has suddenly stopped working.	<ul style="list-style-type: none"> • Check 'Cautions for authenticating a face' and try again.
Door Lock	The door does not lock when I close the door.	<ul style="list-style-type: none"> • The electric lock may be malfunctioning. Have an inspection performed by the installation company.
Time	The time has suddenly become incorrect.	<ul style="list-style-type: none"> • FaceStation 2 is equipped with a built-in battery; however, if power is not supplied for a long period of time, the built-in battery may die, causing the time to become incorrect. For information on correcting the time, referring to Date & Time.
Admin Access	I lost my Admin PIN, so I cannot access the Admin mode.	<ul style="list-style-type: none"> • The administrator grants access permission in FaceStation 2, so only the administrator can access the Admin menu. • If you need to access the Admin menu, you can have a PIN issued through a special procedure. Ask the installation company for the procedure to issue the password.

Product specifications

Category	Feature	Specification
Credential	Biometric	Face
	RF Option	<ul style="list-style-type: none"> FS2-D: 125kHz EM & 13.56Mhz MIFARE, MIFARE Plus, DESFire/EV1, FeliCa, NFC FS2-DS: 125kHz EM & 13.56Mhz MIFARE, MIFARE Plus, DESFire/EV1, FeliCa, NFC FS2-AWB: 125kHz EM, HID Prox & 13.56Mhz MIFARE, MIFARE Plus, DESFire/EV1, FeliCa, iCLASS SE/SR/Seos, NFC, BLE
	RF read range*	MIFARE/DESFire/iCLASS : 50 mm / EM/HID Prox/Felica: 30 mm, BLE: 50 mm
General	LFD	Supported
	CPU	1.4 GHz Quad Core
	Memory	8GB Flash + 1GB RAM
	LCD type	4" color TFT touch
	LCD resolution	800 x 480
	Sound	24 bit/Voice DSP (echo cancel)
	Operating temperature	-20 °C - 50 °C
	Storage temperature	-40 °C - 70 °C
	Operating humidity	0% - 80%, non-condensing
	Storage humidity	0% - 90%, non-condensing
	Camera type	CMOS
	Camera resolution	720 x 480
	Camera angle	Visual Lens: Diagonal 92.7° IR Lens: Diagonal 58°
	Dimension (W x H x D)	141 mm x 164 mm x 125 mm
Capacity	Weight	Device: 628 g Bracket: 74 g (Including washer and bolt)
	Certificates	CE, FCC, KC, RoHS, REACH, WEEE
	Max. User (1:1)	30,000
	Max. User (1:N)	3,000
	Max. Template (1:1)	900,000
	Max. Template (1:N)	90,000
Interface	Max. Text Log	5,000,000
	Max. Image Log	50,000
	Wi-Fi	Supported (Built-in, IEEE802.11 b/g)
	Ethernet	Supported (10/100/1000 Mbps, auto MDI/MDI-X)
	RS-485	1ch Host or Slave (Selectable)
	Wiegand	1ch Input, 1ch Output
	TTL input	2ch Inputs
	Relay	1 Relay
Electrical	USB	USB 2.0 (Host)
	Tamper	Supported
	Power	Voltage: 24 VDC Current: Max. 2.5 A
	Switch input VIH	Min.: 3 V Max.: 5 V
	Switch input VIL	Max.: 1 V
	Switch Pull-up resistance	4.7 kΩ (The input pots are pulled up with 4.7 kΩ.)
	Wiegand output VOH	More than 4.8 V
	Wiegand output VOL	Less than 0.2 V
Wiegand output Pull-up resistance	Internally pulled up with 1 kΩ	
Relay	Voltage: Max. 30 VDC Current: 1 A, Max. 2 A	

* RF read range will vary depending on installation environment.

Dimensions

(Unit: mm)

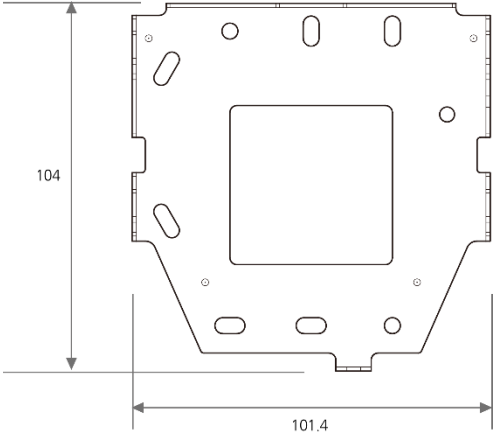
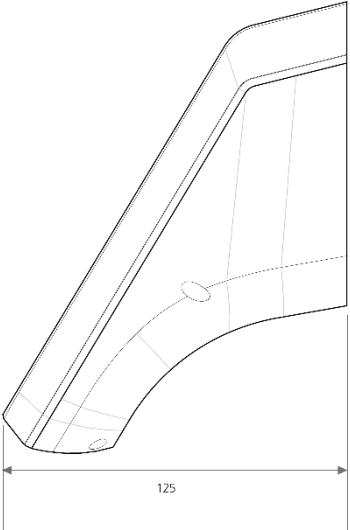
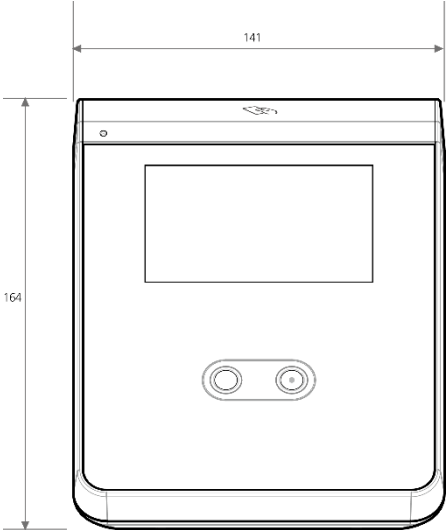

FCC compliance information

THIS DEVICE COMPLIES WITH PART 15 OF THE FCC RULES.

Operation is subject to the following two conditions:

- (1) This device may not cause harmful interference, and
- (2) This device must accept any interference received, including interference that may cause undesired operation.

Note: This equipment has been tested and found to comply with the limits for a Class B digital device, pursuant to part 15 of the FCC Rules. These limits are designed to provide reasonable protection against harmful interference in a residential installation. This equipment generates, uses, and can radiate radio frequency energy and, if not installed and used in accordance with the instructions, may cause harmful interference to radio communications. However, there is no guarantee that interference will not occur in a particular installation. If this equipment does cause harmful interference to radio or television reception, which can be determined by turning the equipment off and on, the user is encouraged to try to correct the interference by one or more of the following measures:

- Reorient or relocate the receiving antenna.
- Increase the separation between the equipment and receiver.
- Connect the equipment to an outlet on a circuit different from that to which the receiver is connected.
- Consult the dealer or an experienced radio/TV technician for help.

Modifications not expressly approved by the manufacturer may void the user's authority to operate the equipment under FCC rules.

This appliance and its antenna must not be located or operated in conjunction with any other antenna or transmitter. A minimum separation distance of 20cm must be maintained between the antenna and individuals for this appliance to satisfy the RF exposure requirements.

EU Declaration of Conformity (CE)

This product is CE marked according to the provisions of the R&TTE Directive (1999/5/EC).

Suprema Inc. hereby declares that this product is in compliance with the essential requirements and other relevant provisions of Directive 1999/5/EC. This device is a class 1 radio device according to the directive.

For more information, contact us using the following contact information.

Suprema Inc.

Website: <https://www.supremainc.com>

Address: Parkview Tower F16, 248, Jeongjail-ro, Bundang-gu, Seongnam-si, Gyeonggi-do, Korea (Jeongja-dong 6)

Tel: 031-783-4510 / Fax: 031-783-4517

Appendices

Disclaimers

- The information in this manual is provided with regard to Suprema products.
- The right to use is acknowledged only for products included in the terms and conditions of the sales agreement guaranteed by Suprema. The right of license to other intellectual property rights not discussed in this manual is not acknowledged.
- Suprema does not guarantee or hold responsibility for the suitability and commerciality of the product for a specific purpose, or the infringement of patent, copyright, or other intellectual property rights with regard to sales or usage of Suprema products.
- Do not use a Suprema product in situations related to medical, rescue of human lives, or maintenance of life, as a person may be injured or killed due to product malfunction. If an accident occurs while a consumer is using the product under the situations described as examples above, employees, subsidiaries, branches, affiliated companies, and distributors of Suprema do not accept responsibility, nor will they be liable for all related direct and indirect expenses or expenditures, including attorney fees, even if the consumer has discovered shortcomings in the product design or manufacturing process and claims this as a significant fault.
- Suprema may modify the product size and specifications at any time without proper notice in order to improve the safety, function, and design of the product. Designers must keep in mind that functions or descriptions indicated as "to be implemented" or "undefined" may change at any time. Suprema will implement or define such functions or descriptions in the near future, and Suprema accepts no responsibility for compatibility issues and any other problems arising from such compatibility issues.
- If you wish to obtain the newest specifications before ordering the product, contact Suprema through a Sales Representative or local distributor of Suprema.

Copyright notice

The copyright of this document is vested in Suprema. The rights of other product names, trademarks, and registered trademarks are vested in each individual or organization that owns such rights.

Open Source License

- The software of this product is based on "Linux Kernel 3.x", which is licensed under GPL. As for GPL, please refer to the [GNU General Public License](#) in this manual.
- This product uses the "OpenSSL", which is licensed under the OpenSSL and Original SSLeay licenses. As for the OpenSSL and Original SSLeay licenses, please refer to [OpenSSL License](#) and [Original SSLeay License](#) in this manual.
- To request the modified source code based on Linux Kernel 3.x which are included in this product, please contact us at tech@supremainc.com.

GNU General Public License

Version 3, 29 June 2007

Copyright © 2007 Free Software Foundation, Inc. <<http://fsf.org/>>

Everyone is permitted to copy and distribute verbatim copies of this license document, but changing it is not allowed.

Preamble

The GNU General Public License is a free, copyleft license for software and other kinds of works.

The licenses for most software and other practical works are designed to take away your freedom to share and change the works. By contrast, the GNU General Public License is intended to guarantee your freedom to share and change all versions of a program--to make sure it remains free software for all its users. We, the Free Software Foundation, use the GNU General Public License for most of our software; it applies also to any other work released this way by its authors. You can apply it to your programs, too.

When we speak of free software, we are referring to freedom, not price. Our General Public Licenses are designed to make sure that you have the freedom to distribute copies of free software (and charge for them if you wish), that you receive source code or can get it if you want it, that you can change the software or use pieces of it in new free programs, and that you know you can do these things.

To protect your rights, we need to prevent others from denying you these rights or asking you to surrender the rights. Therefore, you have certain responsibilities if you distribute copies of the software, or if you modify it: responsibilities to respect the freedom of others.

For example, if you distribute copies of such a program, whether gratis or for a fee, you must pass on to the recipients the same freedoms that you received. You must make sure that they, too, receive or can get the source code. And you must show them these terms so they know their rights.

Developers that use the GNU GPL protect your rights with two steps: (1) assert copyright on the software, and (2) offer you this License giving you legal permission to copy, distribute and/or modify it.

For the developers' and authors' protection, the GPL clearly explains that there is no warranty for this free software. For both users' and authors' sake, the GPL requires that modified versions be marked as changed, so that their problems will not be attributed erroneously to authors of previous versions.

Some devices are designed to deny users access to install or run modified versions of the software inside them, although the manufacturer can do so. This is fundamentally incompatible with the aim of protecting users' freedom to change the software. The systematic pattern of such abuse occurs in the area of products for individuals to use, which is precisely where it is most unacceptable. Therefore, we have designed this version of the GPL to prohibit the practice for those products. If such problems arise substantially in other domains, we stand ready to extend this provision to those domains in future versions of the GPL, as needed to protect the freedom of users.

Finally, every program is threatened constantly by software patents. States should not allow patents to restrict development and use of software on general-purpose computers, but in those that do, we wish to avoid the special danger that patents applied to a free program could make it effectively proprietary. To prevent this, the GPL assures that patents cannot be used to render the program non-free.

The precise terms and conditions for copying, distribution and modification follow.

TERMS AND CONDITIONS

0. Definitions.

"This License" refers to version 3 of the GNU General Public License.

"Copyright" also means copyright-like laws that apply to other kinds of works, such as semiconductor masks.

"The Program" refers to any copyrightable work licensed under this License. Each licensee is addressed as "you". "Licensees" and "recipients" may be individuals or organizations.

To "modify" a work means to copy from or adapt all or part of the work in a fashion requiring copyright permission, other than the making of an exact copy. The resulting work is called a "modified version" of the earlier work or a work "based on" the earlier work.

A "covered work" means either the unmodified Program or a work based on the Program.

To "propagate" a work means to do anything with it that, without permission, would make you directly or secondarily liable for infringement under applicable copyright law, except executing it on a computer or modifying a private copy. Propagation includes copying, distribution (with or without modification), making available to the public, and in some countries other activities as well.

To "convey" a work means any kind of propagation that enables other parties to make or receive copies. Mere interaction with a user through a computer network, with no transfer of a copy, is not conveying.

An interactive user interface displays "Appropriate Legal Notices" to the extent that it includes a convenient and prominently visible feature that (1) displays an appropriate copyright notice, and (2) tells the user that there is no warranty for the work (except to the extent that warranties are provided), that licensees may convey the work under this License, and how to view a copy of this License. If the interface presents a list of user commands or options, such as a menu, a prominent item in the list meets this criterion.

1. Source Code.

The "source code" for a work means the preferred form of the work for making modifications to it. "Object code" means any non-source form of a work.

A "Standard Interface" means an interface that either is an official standard defined by a recognized standards body, or, in the case of interfaces specified for a particular programming language, one that is widely used among developers working in that language.

The "System Libraries" of an executable work include anything, other than the work as a whole, that (a) is included in the normal

form of packaging a Major Component, but which is not part of that Major Component, and (b) serves only to enable use of the work with that Major Component, or to implement a Standard Interface for which an implementation is available to the public in source code form. A "Major Component", in this context, means a major essential component (kernel, window system, and so on) of the specific operating system (if any) on which the executable work runs, or a compiler used to produce the work, or an object code interpreter used to run it.

The "Corresponding Source" for a work in object code form means all the source code needed to generate, install, and (for an executable work) run the object code and to modify the work, including scripts to control those activities. However, it does not include the work's System Libraries, or general-purpose tools or generally available free programs which are used unmodified in performing those activities but which are not part of the work. For example, Corresponding Source includes interface definition files associated with source files for the work, and the source code for shared libraries and dynamically linked subprograms that the work is specifically designed to require, such as by intimate data communication or control flow between those subprograms and other parts of the work.

The Corresponding Source need not include anything that users can regenerate automatically from other parts of the Corresponding Source.

The Corresponding Source for a work in source code form is that same work.

2. Basic Permissions.

All rights granted under this License are granted for the term of copyright on the Program, and are irrevocable provided the stated conditions are met. This License explicitly affirms your unlimited permission to run the unmodified Program. The output from running a covered work is covered by this License only if the output, given its content, constitutes a covered work. This License acknowledges your rights of fair use or other equivalent, as provided by copyright law.

You may make, run and propagate covered works that you do not convey, without conditions so long as your license otherwise remains in force. You may convey covered works to others for the sole purpose of having them make modifications exclusively for you, or provide you with facilities for running those works, provided that you comply with the terms of this License in conveying all material for which you do not control copyright. Those thus making or running the covered works for you must do so exclusively on your behalf, under your direction and control, on terms that prohibit them from making any copies of your copyrighted material outside their relationship with you.

Conveying under any other circumstances is permitted solely under the conditions stated below. Sublicensing is not allowed; section 10 makes it unnecessary.

3. Protecting Users' Legal Rights From Anti-Circumvention Law.

No covered work shall be deemed part of an effective technological measure under any applicable law fulfilling obligations under article 11 of the WIPO copyright treaty adopted on 20 December 1996, or similar laws prohibiting or restricting circumvention of such measures.

When you convey a covered work, you waive any legal power to forbid circumvention of technological measures to the extent such circumvention is effected by exercising rights under this License with respect to the covered work, and you disclaim any intention to limit operation or modification of the work as a means of enforcing, against the work's users, your or third parties' legal rights to forbid circumvention of technological measures.

4. Conveying Verbatim Copies.

You may convey verbatim copies of the Program's source code as you receive it, in any medium, provided that you conspicuously and appropriately publish on each copy an appropriate copyright notice; keep intact all notices stating that this License and any non-permissive terms added in accord with section 7 apply to the code; keep intact all notices of the absence of any warranty; and give all recipients a copy of this License along with the Program.

You may charge any price or no price for each copy that you convey, and you may offer support or warranty protection for a fee.

5. Conveying Modified Source Versions.

You may convey a work based on the Program, or the modifications to produce it from the Program, in the form of source code under the terms of section 4, provided that you also meet all of these conditions:

- a) The work must carry prominent notices stating that you modified it, and giving a relevant date.
- b) The work must carry prominent notices stating that it is released under this License and any conditions added under section 7. This requirement modifies the requirement in section 4 to "keep intact all notices".
- c) You must license the entire work, as a whole, under this License to anyone who comes into possession of a copy. This License will therefore apply, along with any applicable section 7 additional terms, to the whole of the work, and all its parts, regardless of how they are packaged. This License gives no permission to license the work in any other way, but it does not invalidate such permission if you have separately received it.
- d) If the work has interactive user interfaces, each must display Appropriate Legal Notices; however, if the Program has interactive interfaces that do not display Appropriate Legal Notices, your work need not make them do so.

A compilation of a covered work with other separate and independent works, which are not by their nature extensions of the covered work, and which are not combined with it such as to form a larger program, in or on a volume of a storage or distribution medium, is called an "aggregate" if the compilation and its resulting copyright are not used to limit the access or legal rights of the compilation's users beyond what the individual works permit. Inclusion of a covered work in an aggregate does not cause this License to apply to the other parts of the aggregate.

6. Conveying Non-Source Forms.

You may convey a covered work in object code form under the terms of sections 4 and 5, provided that you also convey the machine-readable Corresponding Source under the terms of this License, in one of these ways:

- a) Convey the object code in, or embodied in, a physical product (including a physical distribution medium), accompanied by the Corresponding Source fixed on a durable physical medium customarily used for software interchange.
- b) Convey the object code in, or embodied in, a physical product (including a physical distribution medium), accompanied by a written offer, valid for at least three years and valid for as long as you offer spare parts or customer support for that product model, to give anyone who possesses the object code either (1) a copy of the Corresponding Source for all the software in the product that is covered by this License, on a durable physical medium customarily used for software interchange, for a price no more than your reasonable cost of physically performing this conveying of source, or (2) access to copy the Corresponding Source from a network server at no charge.
- c) Convey individual copies of the object code with a copy of the written offer to provide the Corresponding Source. This alternative is allowed only occasionally and noncommercially, and only if you received the object code with such an offer, in accord with subsection 6b.
- d) Convey the object code by offering access from a designated place (gratis or for a charge), and offer equivalent access to the Corresponding Source in the same way through the same place at no further charge. You need not require recipients to copy the Corresponding Source along with the object code. If the place to copy the object code is a network server, the Corresponding Source may be on a different server (operated by you or a third party) that supports equivalent copying facilities, provided you maintain clear directions next to the object code saying where to find the Corresponding Source. Regardless of what server hosts the Corresponding Source, you remain obligated to ensure that it is available for as long as needed to satisfy these requirements.
- e) Convey the object code using peer-to-peer transmission, provided you inform other peers where the object code and Corresponding Source of the work are being offered to the general public at no charge under subsection 6d.

A separable portion of the object code, whose source code is excluded from the Corresponding Source as a System Library, need not be included in conveying the object code work.

A "User Product" is either (1) a "consumer product", which means any tangible personal property which is normally used for personal, family, or household purposes, or (2) anything designed or sold for incorporation into a dwelling. In determining whether a product is a consumer product, doubtful cases shall be resolved in favor of coverage. For a particular product received by a particular user, "normally used" refers to a typical or common use of that class of product, regardless of the status of the particular user or of the way in which the particular user actually uses, or expects or is expected to use, the product. A product is a consumer product regardless of whether the product has substantial commercial, industrial or non-consumer uses, unless such uses represent the only significant mode of use of the product.

"Installation Information" for a User Product means any methods, procedures, authorization keys, or other information required to install and execute modified versions of a covered work in that User Product from a modified version of its Corresponding Source. The information must suffice to ensure that the continued functioning of the modified object code is in no case prevented or interfered with solely because modification has been made.

If you convey an object code work under this section in, or with, or specifically for use in, a User Product, and the conveying occurs as part of a transaction in which the right of possession and use of the User Product is transferred to the recipient in perpetuity or for a fixed term (regardless of how the transaction is characterized), the Corresponding Source conveyed under this section must be accompanied by the Installation Information. But this requirement does not apply if neither you nor any third party retains the ability to install modified object code on the User Product (for example, the work has been installed in ROM).

The requirement to provide Installation Information does not include a requirement to continue to provide support service, warranty, or updates for a work that has been modified or installed by the recipient, or for the User Product in which it has been modified or installed. Access to a network may be denied when the modification itself materially and adversely affects the operation of the network or violates the rules and protocols for communication across the network.

Corresponding Source conveyed, and Installation Information provided, in accord with this section must be in a format that is publicly documented (and with an implementation available to the public in source code form), and must require no special password or key for unpacking, reading or copying.

7. Additional Terms.

"Additional permissions" are terms that supplement the terms of this License by making exceptions from one or more of its conditions. Additional permissions that are applicable to the entire Program shall be treated as though they were included in this License, to the extent that they are valid under applicable law. If additional permissions apply only to part of the Program, that

part may be used separately under those permissions, but the entire Program remains governed by this License without regard to the additional permissions.

When you convey a copy of a covered work, you may at your option remove any additional permissions from that copy, or from any part of it. (Additional permissions may be written to require their own removal in certain cases when you modify the work.) You may place additional permissions on material, added by you to a covered work, for which you have or can give appropriate copyright permission.

Notwithstanding any other provision of this License, for material you add to a covered work, you may (if authorized by the copyright holders of that material) supplement the terms of this License with terms:

- a) Disclaiming warranty or limiting liability differently from the terms of sections 15 and 16 of this License; or
- b) Requiring preservation of specified reasonable legal notices or author attributions in that material or in the Appropriate Legal Notices displayed by works containing it; or
- c) Prohibiting misrepresentation of the origin of that material, or requiring that modified versions of such material be marked in reasonable ways as different from the original version; or
- d) Limiting the use for publicity purposes of names of licensors or authors of the material; or
- e) Declining to grant rights under trademark law for use of some trade names, trademarks, or service marks; or
- f) Requiring indemnification of licensors and authors of that material by anyone who conveys the material (or modified versions of it) with contractual assumptions of liability to the recipient, for any liability that these contractual assumptions directly impose on those licensors and authors.

All other non-permissive additional terms are considered “further restrictions” within the meaning of section 10. If the Program as you received it, or any part of it, contains a notice stating that it is governed by this License along with a term that is a further restriction, you may remove that term. If a license document contains a further restriction but permits relicensing or conveying under this License, you may add to a covered work material governed by the terms of that license document, provided that the further restriction does not survive such relicensing or conveying.

If you add terms to a covered work in accord with this section, you must place, in the relevant source files, a statement of the additional terms that apply to those files, or a notice indicating where to find the applicable terms.

Additional terms, permissive or non-permissive, may be stated in the form of a separately written license, or stated as exceptions; the above requirements apply either way.

8. Termination.

You may not propagate or modify a covered work except as expressly provided under this License. Any attempt otherwise to propagate or modify it is void, and will automatically terminate your rights under this License (including any patent licenses granted under the third paragraph of section 11).

However, if you cease all violation of this License, then your license from a particular copyright holder is reinstated (a) provisionally, unless and until the copyright holder explicitly and finally terminates your license, and (b) permanently, if the copyright holder fails to notify you of the violation by some reasonable means prior to 60 days after the cessation.

Moreover, your license from a particular copyright holder is reinstated permanently if the copyright holder notifies you of the violation by some reasonable means, this is the first time you have received notice of violation of this License (for any work) from that copyright holder, and you cure the violation prior to 30 days after your receipt of the notice.

Termination of your rights under this section does not terminate the licenses of parties who have received copies or rights from you under this License. If your rights have been terminated and not permanently reinstated, you do not qualify to receive new licenses for the same material under section 10.

9. Acceptance Not Required for Having Copies.

You are not required to accept this License in order to receive or run a copy of the Program. Ancillary propagation of a covered work occurring solely as a consequence of using peer-to-peer transmission to receive a copy likewise does not require acceptance. However, nothing other than this License grants you permission to propagate or modify any covered work. These actions infringe copyright if you do not accept this License. Therefore, by modifying or propagating a covered work, you indicate your acceptance of this License to do so.

10. Automatic Licensing of Downstream Recipients.

Each time you convey a covered work, the recipient automatically receives a license from the original licensors, to run, modify and propagate that work, subject to this License. You are not responsible for enforcing compliance by third parties with this License.

An “entity transaction” is a transaction transferring control of an organization, or substantially all assets of one, or subdividing an organization, or merging organizations. If propagation of a covered work results from an entity transaction, each party to that transaction who receives a copy of the work also receives whatever licenses to the work the party’s predecessor in interest had or could give under the previous paragraph, plus a right to possession of the Corresponding Source of the work from the predecessor in interest, if the predecessor has it or can get it with reasonable efforts.

You may not impose any further restrictions on the exercise of the rights granted or affirmed under this License. For example, you may not impose a license fee, royalty, or other charge for exercise of rights granted under this License, and you may not initiate litigation (including a cross-claim or counterclaim in a lawsuit) alleging that any patent claim is infringed by making, using, selling, offering for sale, or importing the Program or any portion of it.

11. Patents.

A "contributor" is a copyright holder who authorizes use under this License of the Program or a work on which the Program is based. The work thus licensed is called the contributor's "contributor version".

A contributor's "essential patent claims" are all patent claims owned or controlled by the contributor, whether already acquired or hereafter acquired, that would be infringed by some manner, permitted by this License, of making, using, or selling its contributor version, but do not include claims that would be infringed only as a consequence of further modification of the contributor version. For purposes of this definition, "control" includes the right to grant patent sublicenses in a manner consistent with the requirements of this License.

Each contributor grants you a non-exclusive, worldwide, royalty-free patent license under the contributor's essential patent claims, to make, use, sell, offer for sale, import and otherwise run, modify and propagate the contents of its contributor version.

In the following three paragraphs, a "patent license" is any express agreement or commitment, however denominated, not to enforce a patent (such as an express permission to practice a patent or covenant not to sue for patent infringement). To "grant" such a patent license to a party means to make such an agreement or commitment not to enforce a patent against the party.

If you convey a covered work, knowingly relying on a patent license, and the Corresponding Source of the work is not available for anyone to copy, free of charge and under the terms of this License, through a publicly available network server or other readily accessible means, then you must either (1) cause the Corresponding Source to be so available, or (2) arrange to deprive yourself of the benefit of the patent license for this particular work, or (3) arrange, in a manner consistent with the requirements of this License, to extend the patent license to downstream recipients. "Knowingly relying" means you have actual knowledge that, but for the patent license, your conveying the covered work in a country, or your recipient's use of the covered work in a country, would infringe one or more identifiable patents in that country that you have reason to believe are valid.

If, pursuant to or in connection with a single transaction or arrangement, you convey, or propagate by procuring conveyance of, a covered work, and grant a patent license to some of the parties receiving the covered work authorizing them to use, propagate, modify or convey a specific copy of the covered work, then the patent license you grant is automatically extended to all recipients of the covered work and works based on it.

A patent license is "discriminatory" if it does not include within the scope of its coverage, prohibits the exercise of, or is conditioned on the non-exercise of one or more of the rights that are specifically granted under this License. You may not convey a covered work if you are a party to an arrangement with a third party that is in the business of distributing software, under which you make payment to the third party based on the extent of your activity of conveying the work, and under which the third party grants, to any of the parties who would receive the covered work from you, a discriminatory patent license (a) in connection with copies of the covered work conveyed by you (or copies made from those copies), or (b) primarily for and in connection with specific products or compilations that contain the covered work, unless you entered into that arrangement, or that patent license was granted, prior to 28 March 2007.

Nothing in this License shall be construed as excluding or limiting any implied license or other defenses to infringement that may otherwise be available to you under applicable patent law.

12. No Surrender of Others' Freedom.

If conditions are imposed on you (whether by court order, agreement or otherwise) that contradict the conditions of this License, they do not excuse you from the conditions of this License. If you cannot convey a covered work so as to satisfy simultaneously your obligations under this License and any other pertinent obligations, then as a consequence you may not convey it at all. For example, if you agree to terms that obligate you to collect a royalty for further conveying from those to whom you convey the Program, the only way you could satisfy both those terms and this License would be to refrain entirely from conveying the Program.

13. Use with the GNU Affero General Public License.

Notwithstanding any other provision of this License, you have permission to link or combine any covered work with a work licensed under version 3 of the GNU Affero General Public License into a single combined work, and to convey the resulting work. The terms of this License will continue to apply to the part which is the covered work, but the special requirements of the GNU Affero General Public License, section 13, concerning interaction through a network will apply to the combination as such.

14. Revised Versions of this License.

The Free Software Foundation may publish revised and/or new versions of the GNU General Public License from time to time. Such new versions will be similar in spirit to the present version, but may differ in detail to address new problems or concerns.

Each version is given a distinguishing version number. If the Program specifies that a certain numbered version of the GNU

General Public License "or any later version" applies to it, you have the option of following the terms and conditions either of that numbered version or of any later version published by the Free Software Foundation. If the Program does not specify a version number of the GNU General Public License, you may choose any version ever published by the Free Software Foundation.

If the Program specifies that a proxy can decide which future versions of the GNU General Public License can be used, that proxy's public statement of acceptance of a version permanently authorizes you to choose that version for the Program.

Later license versions may give you additional or different permissions. However, no additional obligations are imposed on any author or copyright holder as a result of your choosing to follow a later version.

15. Disclaimer of Warranty.

THERE IS NO WARRANTY FOR THE PROGRAM, TO THE EXTENT PERMITTED BY APPLICABLE LAW. EXCEPT WHEN OTHERWISE STATED IN WRITING THE COPYRIGHT HOLDERS AND/OR OTHER PARTIES PROVIDE THE PROGRAM "AS IS" WITHOUT WARRANTY OF ANY KIND, EITHER EXPRESSED OR IMPLIED, INCLUDING, BUT NOT LIMITED TO, THE IMPLIED WARRANTIES OF MERCHANTABILITY AND FITNESS FOR A PARTICULAR PURPOSE. THE ENTIRE RISK AS TO THE QUALITY AND PERFORMANCE OF THE PROGRAM IS WITH YOU. SHOULD THE PROGRAM PROVE DEFECTIVE, YOU ASSUME THE COST OF ALL NECESSARY SERVICING, REPAIR OR CORRECTION.

16. Limitation of Liability.

IN NO EVENT UNLESS REQUIRED BY APPLICABLE LAW OR AGREED TO IN WRITING WILL ANY COPYRIGHT HOLDER, OR ANY OTHER PARTY WHO MODIFIES AND/OR CONVEYS THE PROGRAM AS PERMITTED ABOVE, BE LIABLE TO YOU FOR DAMAGES, INCLUDING ANY GENERAL, SPECIAL, INCIDENTAL OR CONSEQUENTIAL DAMAGES ARISING OUT OF THE USE OR INABILITY TO USE THE PROGRAM (INCLUDING BUT NOT LIMITED TO LOSS OF DATA OR DATA BEING RENDERED INACCURATE OR LOSSES SUSTAINED BY YOU OR THIRD PARTIES OR A FAILURE OF THE PROGRAM TO OPERATE WITH ANY OTHER PROGRAMS), EVEN IF SUCH HOLDER OR OTHER PARTY HAS BEEN ADVISED OF THE POSSIBILITY OF SUCH DAMAGES.

17. Interpretation of Sections 15 and 16.

If the disclaimer of warranty and limitation of liability provided above cannot be given local legal effect according to their terms, reviewing courts shall apply local law that most closely approximates an absolute waiver of all civil liability in connection with the Program, unless a warranty or assumption of liability accompanies a copy of the Program in return for a fee.

END OF TERMS AND CONDITIONS

OpenSSL License

Copyright (c) 1998-2017 The OpenSSL Project. All rights reserved.

Redistribution and use in source and binary forms, with or without modification, are permitted provided that the following conditions are met:

1. Redistributions of source code must retain the above copyright notice, this list of conditions and the following disclaimer.
2. Redistributions in binary form must reproduce the above copyright notice, this list of conditions and the following disclaimer in the documentation and/or other materials provided with the distribution.
3. All advertising materials mentioning features or use of this software must display the following acknowledgment: "This product includes software developed by the OpenSSL Project for use in the OpenSSL Toolkit. (<http://www.openssl.org/>)"
4. The names "OpenSSL Toolkit" and "OpenSSL Project" must not be used to endorse or promote products derived from this software without prior written permission. For written permission, please contact openssl-core@openssl.org.
5. Products derived from this software may not be called "OpenSSL" nor may "OpenSSL" appear in their names without prior written permission of the OpenSSL Project.
6. Redistributions of any form whatsoever must retain the following acknowledgment: "This product includes software developed by the OpenSSL Project for use in the OpenSSL Toolkit (<http://www.openssl.org/>)"

THIS SOFTWARE IS PROVIDED BY THE OpenSSL PROJECT "AS IS" AND ANY EXPRESSED OR IMPLIED WARRANTIES, INCLUDING, BUT NOT LIMITED TO, THE IMPLIED WARRANTIES OF MERCHANTABILITY AND FITNESS FOR A PARTICULAR PURPOSE ARE DISCLAIMED. IN NO EVENT SHALL THE OpenSSL PROJECT OR ITS CONTRIBUTORS BE LIABLE FOR ANY DIRECT, INDIRECT, INCIDENTAL, SPECIAL, EXEMPLARY, OR CONSEQUENTIAL DAMAGES (INCLUDING, BUT NOT LIMITED TO, PROCUREMENT OF SUBSTITUTE GOODS OR SERVICES; LOSS OF USE, DATA, OR PROFITS; OR BUSINESS INTERRUPTION) HOWEVER CAUSED AND ON ANY THEORY OF LIABILITY, WHETHER IN CONTRACT, STRICT LIABILITY, OR TORT (INCLUDING NEGLIGENCE OR OTHERWISE) ARISING IN ANY WAY OUT OF THE USE OF THIS SOFTWARE, EVEN IF ADVISED OF THE POSSIBILITY OF SUCH DAMAGE.

This product includes cryptographic software written by Eric Young (eay@cryptsoft.com). This product includes software written by Tim Hudson (tjh@cryptsoft.com).

Original SSLeay License

Copyright (C) 1995-1998 Eric Young (eay@cryptsoft.com) All rights reserved.

This package is an SSL implementation written by Eric Young (eay@cryptsoft.com). The implementation was written so as to conform with Netscapes SSL.

This library is free for commercial and non-commercial use as long as the following conditions are adhered to. The following conditions apply to all code found in this distribution, be it the RC4, RSA, lhash, DES, etc., code; not just the SSL code. The SSL documentation included with this distribution is covered by the same copyright terms except that the holder is Tim Hudson (tjh@cryptsoft.com).

Copyright remains Eric Young's, and as such any Copyright notices in the code are not to be removed. If this package is used in a product, Eric Young should be given attribution as the author of the parts of the library used. This can be in the form of a textual message at program startup or in documentation (online or textual) provided with the package.

Redistribution and use in source and binary forms, with or without modification, are permitted provided that the following conditions are met:

1. Redistributions of source code must retain the copyright notice, this list of conditions and the following disclaimer.
2. Redistributions in binary form must reproduce the above copyright notice, this list of conditions and the following disclaimer in the documentation and/or other materials provided with the distribution.
3. All advertising materials mentioning features or use of this software must display the following acknowledgement: "This product includes cryptographic software written by Eric Young (eay@cryptsoft.com)" The word 'cryptographic' can be left out if the routines from the library being used are not cryptographic related :-).
4. If you include any Windows specific code (or a derivative thereof) from the apps directory (application code) you must include an acknowledgement: "This product includes software written by Tim Hudson (tjh@cryptsoft.com)"

THIS SOFTWARE IS PROVIDED BY ERIC YOUNG ``AS IS'' AND ANY EXPRESS OR IMPLIED WARRANTIES, INCLUDING, BUT NOT LIMITED TO, THE IMPLIED WARRANTIES OF MERCHANTABILITY AND FITNESS FOR A PARTICULAR PURPOSE ARE DISCLAIMED. IN NO EVENT SHALL THE AUTHOR OR CONTRIBUTORS BE LIABLE FOR ANY DIRECT, INDIRECT, INCIDENTAL, SPECIAL, EXEMPLARY, OR CONSEQUENTIAL DAMAGES (INCLUDING, BUT NOT LIMITED TO, PROCUREMENT OF SUBSTITUTE GOODS OR SERVICES; LOSS OF USE, DATA, OR PROFITS; OR BUSINESS INTERRUPTION) HOWEVER CAUSED AND ON ANY THEORY OF LIABILITY, WHETHER IN CONTRACT, STRICT LIABILITY, OR TORT (INCLUDING NEGLIGENCE OR OTHERWISE) ARISING IN ANY WAY OUT OF THE USE OF THIS SOFTWARE, EVEN IF ADVISED OF THE POSSIBILITY OF SUCH DAMAGE.

The licence and distribution terms for any publically available version or derivative of this code cannot be changed. i.e. this code cannot simply be copied and put under another distribution licence [including the GNU Public Licence.]

The logo for Suprema Inc. features the word "suprema" in a white, lowercase, sans-serif font. Below it, the words "BIOMETRICS & SECURITY" are written in a smaller, all-caps, sans-serif font. The entire logo is set against a dark red rectangular background.

suprema
BIOMETRICS & SECURITY

Suprema Inc.

16F Parkview Tower, 248, Jeongjail-ro, Bundang- gu, Seongnam-si, Gyeonggi-do, 13554, Rep. of KOREA
Tel: +82 31 783 4502 | Fax: +82 31 783 4503 | Inquiry: sales@supremainc.com

©2018 Suprema Inc. Suprema and identifying product names and numbers herein are registered trade marks of Suprema, Inc. All non-Suprema brands and product names are trademarks or registered trademarks of their respective companies. Product appearance, build status and/or specifications are subject to change without notice.