

Suprema Integration with Paxton Net2

# ADMINISTRATOR GUIDE

Version 1.01  
English

# Contents

---

<b>Target Audience</b> .....	<b>4</b>
<b>Introduction</b> .....	<b>5</b>
Features.....	5
System diagram.....	5
<b>Installation</b> .....	<b>6</b>
System Environment .....	6
Compatible Systems and Devices .....	6
Installing the Suprema Integration with Paxton Net2 .....	7
<b>Getting started</b> .....	<b>11</b>
Activate the Paxton Net2 OEM Client.....	11
Login.....	11
Home.....	12
<b>Devices</b> .....	<b>13</b>
Devices Overview.....	13
Adding the Device (from the Server).....	14
Search and Registration.....	14
Enter the Device IP .....	14
Adding the Device (from the Device) .....	15
Upload Users Registered from Devices .....	16
Editing Device Settings and Information.....	17
Resend Configuration .....	18
Upgrade F/W.....	18
Connect Device.....	18
Remove Device.....	19
Other Settings .....	19
<b>Users</b> .....	<b>20</b>
Users Overview.....	20
Select Card.....	20
Enroll Pin.....	21
Enroll Fingerprint.....	21
Server.....	21
Device .....	22
Enroll Face.....	23
Server.....	23
Device .....	24
Resend to All Devices .....	24
<b>Monitoring</b> .....	<b>25</b>
<b>Audit Trail</b> .....	<b>26</b>
<b>Accounts</b> .....	<b>27</b>
<b>Settings</b> .....	<b>29</b>
Global Device Configuration .....	29
Server Setting.....	30
<b>Enrollment Helper Client</b> .....	<b>31</b>

Enroll Credentials with Enrollment Helper .....31  
    Enroll Credentials to Existing User .....31  
    Enroll Credentials to New User .....33

**Appendices .....35**

Disclaimers .....35  
Copyright Notice .....35  
Open Source License .....35  
    gin-gonic/gin .....35  
    Gorm .....36  
    Go-ps .....36  
    google/uuid .....36  
    gorilla/websocket .....37  
    CommandLineParser .....37  
    MahApps Metro .....38  
    MahApps Metro IconPacks .....38  
    Newtonsoft.Json .....38  
    Aphache/log4net .....39

## Target Audience

This document describes the integration between Suprema biometric devices and Paxton Net2 Access Control system using the Suprema Integration with Paxton Net2.

This document is intended for OEM Clients. The OEM Clients require basic knowledge of the Paxton Net2 and Suprema biometric devices.

# Introduction

## Features

Suprema Integration with Paxton Net2 is a middleware that allows the Paxton Net2 Access Control System to communicate with the Suprema biometric devices, which can register a variety of credentials to users from the Net2, and to manage connected devices. With Suprema Integration with Paxton Net2, you can easily setup and build the Biometric Management System for the Net2 using Suprema biometric devices.

Suprema Integration with Paxton Net2 provides the following features.

- **Enable Biometrics:** Not only the RFID cards and PINs but also fingerprints and face as credentials.
- **Easy User Management:** No need to register or manage users separately because user data on Net2 Access Control system is synchronized in real time.
- **Easy Enrollment and Management:** Allows to register the user's credentials directly from the device.
- **Enterprise-level Configuration:** Allows to connect and manage up to 1,000 Biometric Devices.

### NOTE

- For more details on the functionality of Paxton Net2 access control system, see the user manuals for Net2.

## System diagram

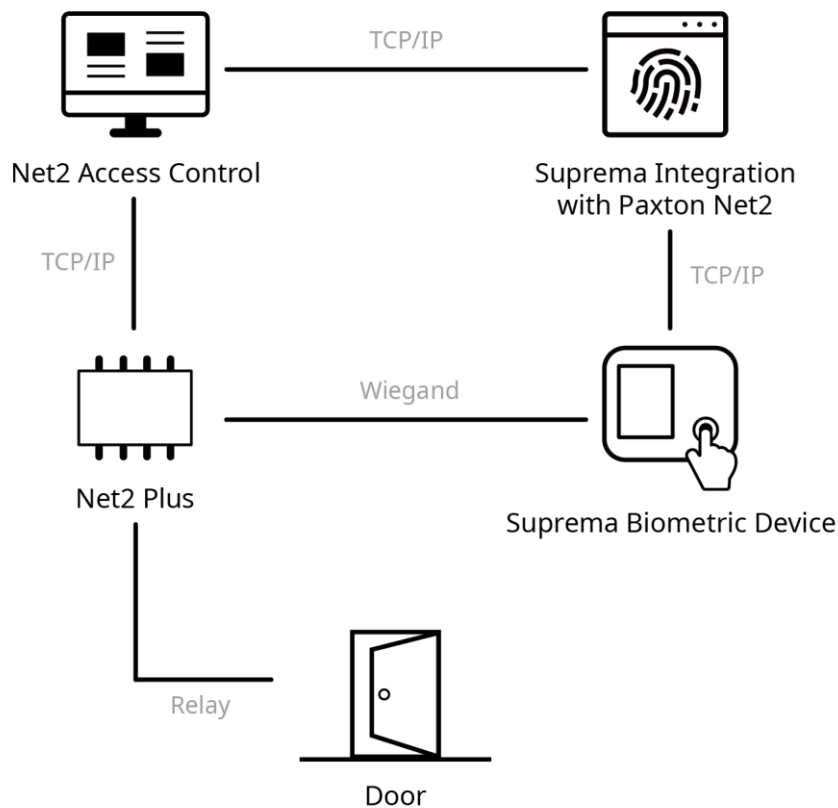

# Installation

## System Environment

Suprema Integration with Paxton Net2 operates normally in the same system environment as Paxton Net2. You can find the minimum system requirements for Paxton Net2 at <https://www.paxton-access.com/systems/net2/access-control-software/net2-software-compatibility-and-support/>. Check the support conditions before installing the Suprema Integration with Paxton Net2.

## Compatible Systems and Devices

- Operating System
  - Microsoft Windows 8 or later
- Paxton Net2 Access Control
  - V6.01.8319.4827
- Suprema Biometric Device
  - FaceStation 2, FaceLite, BioStation 2, BioStation A2, BioStation L2, BioLite N2, BioEntry W2, BioEntry P2
- USB Fingerprint Scanner
  - BioMini Plus 2

## Installing the Suprema Integration with Paxton Net2

### NOTE

- This section describes how to install the Suprema Integration with Paxton Net2. For more details on the installation of the Paxton Net2 System, see the manuals for the Net2.

- Run the downloaded setup program.  
(ex. 'Setup.for.suprema.integration.with.paxton.net2.x64.x.xxxx')
- To continue the installation, select **I accept the agreement** and click **Next**.

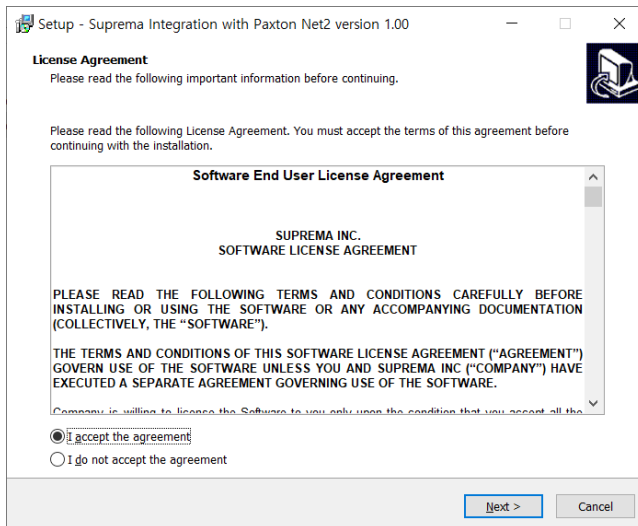

- Click **Next** after setting a path for Suprema Integration with Paxton Net2 to be installed.

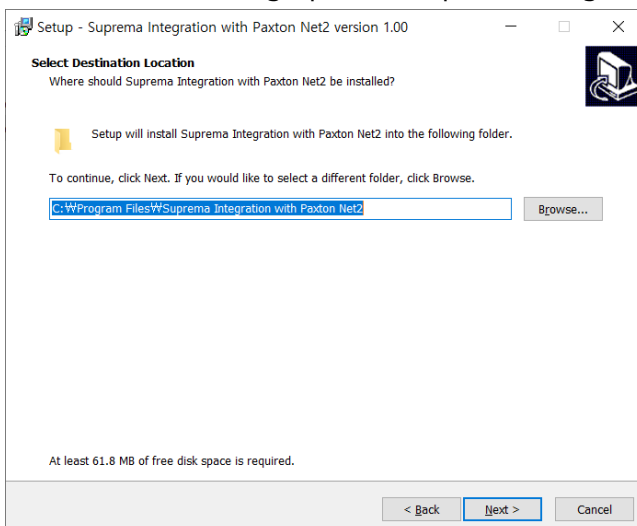

#### 4 Click **Next** after selecting the components to install.

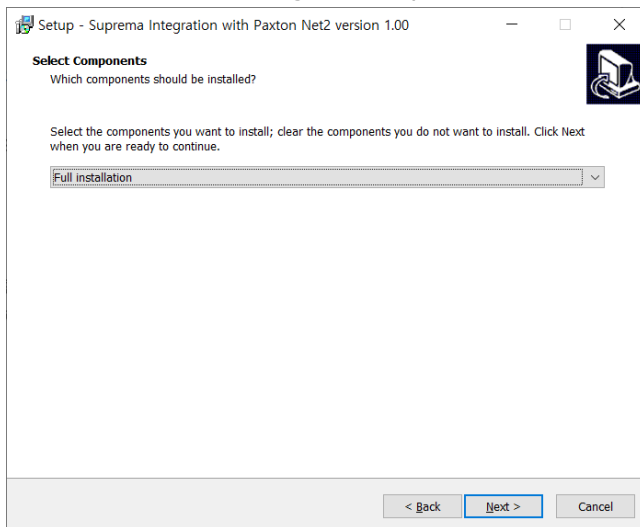

#### 5 Enter the password for OEM Client account and click **Next**.

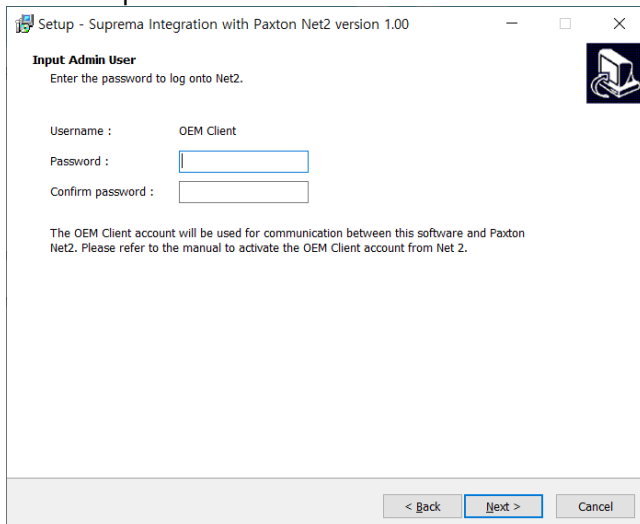

#### NOTE

- The OEM Client account must be set up to sync user information stored in Net2 Access Control. Activate the OEM client account by referring to [Activate the Paxton Net2 OEM Client](#).



6 Enter the Suprema device admin ID and PIN, and then click **Next**. The ID and PIN set in this step will be used when you log in to Suprema Integration with Paxton Net2 or to access the devices.

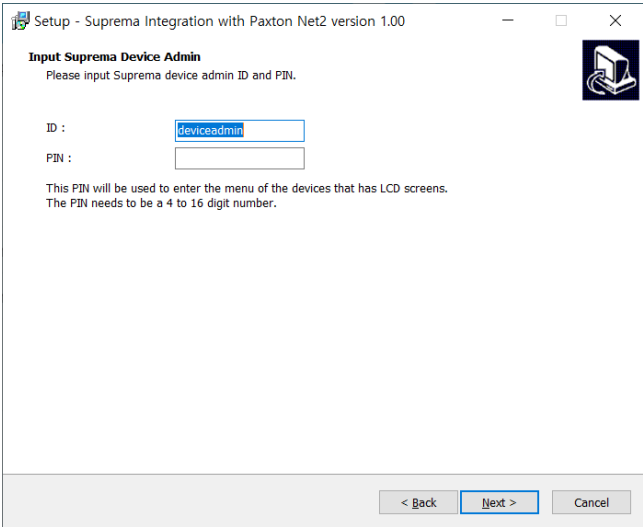

7 Input the server IP and port number.

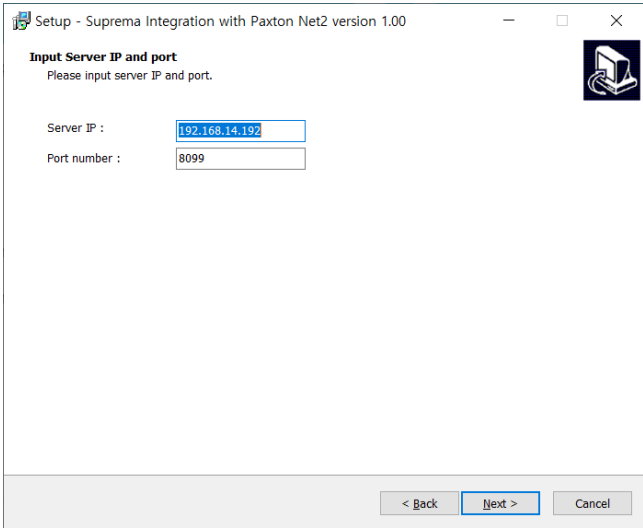

8 To create a shortcut on the desktop, select **Create a desktop shortcut** and click **Next**.

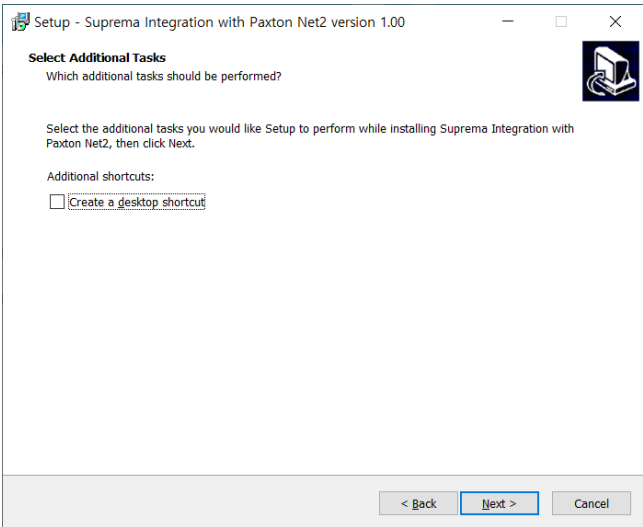

## 9 If ready to install, click **Install**.

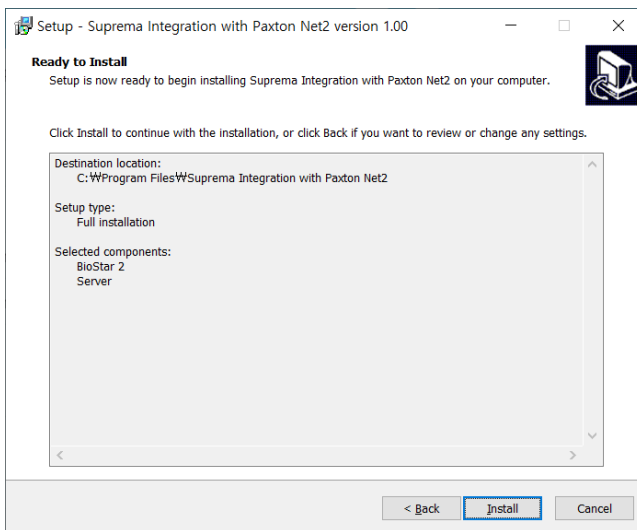

## 10 Select whether to install additional program and click **Finish**.

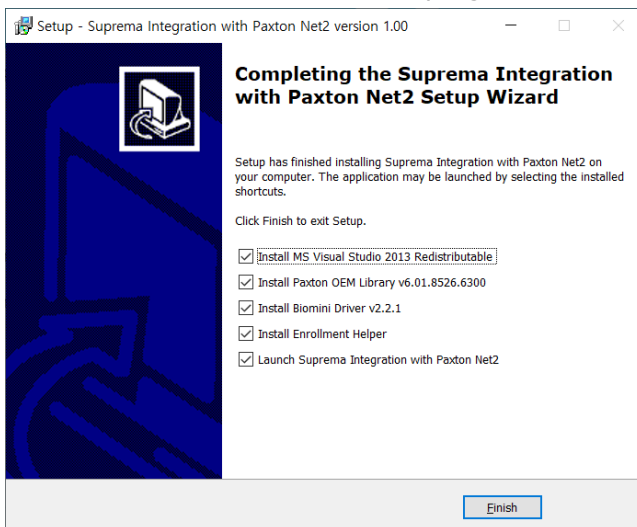

### NOTE

- If you install the Enrollment Helper, you can also enroll fingerprints by opening a window for fingerprint enrollment directly from the Net2 Access Control system. For more information on the Enrollment Helper, refer to [Enrollment Helper Client](#).

# Getting started

## Activate the Paxton Net2 OEM Client

In order to use Suprema Integration with Paxton Net2, you must first activate the OEM Client on Paxton Net2.

- 1 Run **Net2 Access Control**.
- 2 Click **Net2 operators** and double-click **OEM Client**.
- 3 Enter the desired password in the **Password** and **Confirm password** field.

- 4 Click **Finish** to activate the OEM Client.

### NOTE

- For more details on the Net2 Access Control system, see the manuals for the Net2.

## Login

Log in with the device administrator account.

The ID is '**deviceadmin**', and PIN is the password you set when you installed Suprema Integration with Paxton Net2.

## Home

The **Home** menu is the starting point for accessing all menus of the Suprema Integration with Paxton Net2. You can also check the number of registered devices, users, faces, fingerprints, and cards.

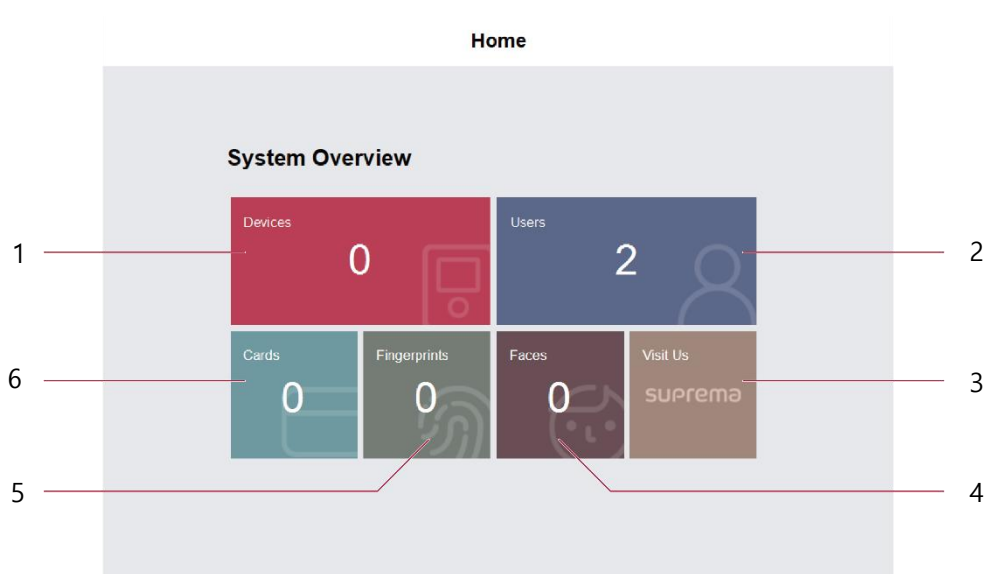

<b>1</b>	You can view the number of connected devices.	<b>4</b>	You can view the number of registered faces.
<b>2</b>	You can view the number of registered users.	<b>5</b>	You can view the number of registered fingerprints.
<b>3</b>	You can access the Suprema website.	<b>6</b>	You can view the number of registered cards.

# Devices

## Devices Overview

You can use the Devices menu to add, delete or edit registered devices, fetch the user information registered within the device to the server or upgrade the firmware.

Devices							
	ID	NAME	TYPE	DIRECTION	IP	PORT	STATUS
	547832712	Facelite		Server To Device	192.168.14.240	51211	disconnected
	546832506	Biostation 2		Server To Device	192.168.14.221	51211	connected

Search Device Add Device View Users Resend Config Upgrade F/W Connect Remove

- **Search Device:** You can search for devices connected to Suprema Integration with Paxton Net2 and register them.
- **Add Device:** You can add a device by entering the IP of the device.
- **View Users:** You can see a list of users stored on devices.
- **Resend Config:** You can apply device settings configured in the **Settings** menu to devices.
- **Upgrade F/W:** You can upgrade the device's firmware.
- **Connect:** You can reconnect the selected device to the Suprema Integration with Paxton Net2.
- **Remove:** You can remove the selected device from the Suprema Integration with Paxton Net2.

## Adding the Device (from the Server)

### Search and Registration

You can automatically search for devices connected to Suprema Integration with Paxton Net2 and register them. Before searching for devices, check whether they are correctly connected. When adding multiple devices at once, it will be more convenient to know the ID, Type and IP address information of each device in advance.

- 1 Click  to move to the **Devices** menu.
- 2 Click **Search Device**. All available devices will appear.

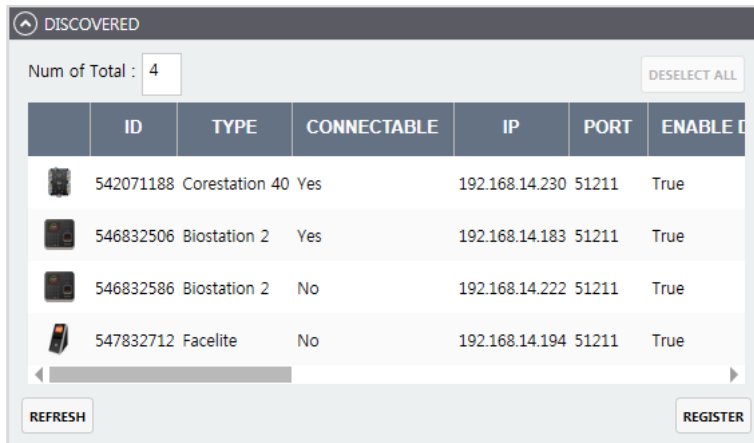

The screenshot shows a window titled "DISCOVERED" with a "Num of Total : 4" indicator and a "DESELECT ALL" button. Below is a table with columns: ID, TYPE, CONNECTABLE, IP, PORT, and ENABLE D. The table contains four rows of device information.

ID	TYPE	CONNECTABLE	IP	PORT	ENABLE D
542071188	Corestation 40	Yes	192.168.14.230	51211	True
546832506	Biostation 2	Yes	192.168.14.183	51211	True
546832586	Biostation 2	No	192.168.14.222	51211	True
547832712	Facelite	No	192.168.14.194	51211	True

At the bottom of the window, there are "REFRESH" and "REGISTER" buttons.

- 3 Select the device to connect and click **REGISTER**.

### Enter the Device IP

You can add a device by entering the IP of the device.

- 1 Click  to move to the **Devices** menu.
- 2 Click **Add Device**.
- 3 Enter the IP of the device to register and click **Okay**.



The screenshot shows a dialog box titled "Add Device" with the instruction "Input the IP of the device." Below the instruction is a text input field labeled "IP". At the bottom of the dialog box, there are two buttons: "Okay" and "Cancel".

- 4 Click **Okay**.

#### NOTE

- Up to 1,000 biometric devices can be connected.

## Adding the Device (from the Device)

You can configure the device to send a connection request to Suprema Integration with Paxton Net 2 by setting the server information. The steps may vary depending on the device you use. For more details, refer to the manual. In this section, BioStation A2 is in use.

- 1 On the device, press **■** > **NETWORK**.
- 2 Press **Server** and activate **Device -> Server**.
- 3 Enter the IP address on **Server IP**. The device will automatically request the connection to the server.
- 4 On the server, press **OK**.

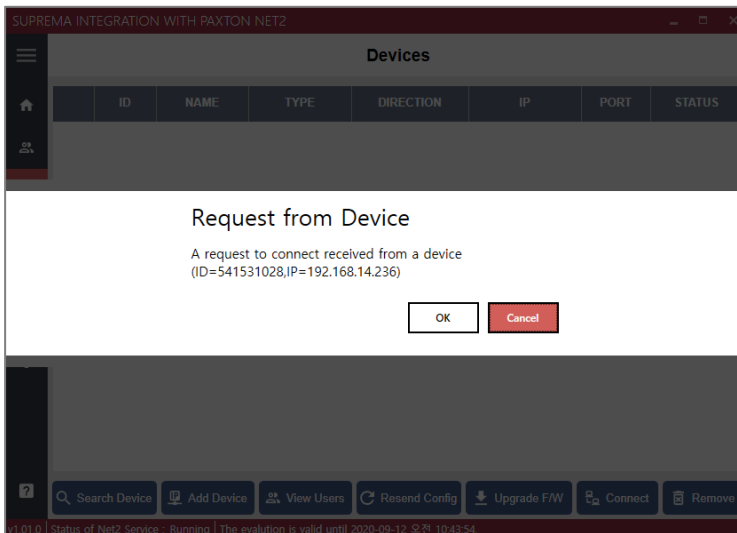



















The device is added on the list.

## Upload Users Registered from Devices

You can view the list of users stored on the device and import the users to the server.

- 1 Click  to move to the **Devices** menu.
- 2 Click a device to view the list of users.
- 3 Select all users to upload to the server and click **Upload from the device**.

USERS TO UPLOAD									
	USER ID	NAME					EXPIRED AT	DISABLED	ACCESSIBLE
	manager	manager	0	0	0	False	12 31, 2030 11:59	false	<input type="checkbox"/>
	deviceadmin	deviceadmin	0	0	0	True	12 31, 2030 11:59	false	<input checked="" type="checkbox"/>
	201	ky	0	2	0	False	12 31, 2030 11:59	false	<input type="checkbox"/>
	200		1	1	0	False	12 31, 2030 11:59	false	<input type="checkbox"/>
	33	AAA	0	2	0	False	12 31, 2030 11:59	false	<input type="checkbox"/>
	6	9093	1	0	0	False	12 31, 2030 11:59	false	<input checked="" type="checkbox"/>
	5	9092	1	0	0	False	12 31, 2030 11:59	false	<input checked="" type="checkbox"/>
	4	9091	1	0	0	False	12 31, 2030 11:59	false	<input checked="" type="checkbox"/>
	3	9090	1	0	0	False	12 31, 2030 11:59	false	<input checked="" type="checkbox"/>
	2	JaceyRyu	0	0	0	False	12 31, 2030 11:59	false	<input checked="" type="checkbox"/>
	1	SimbaPark	0	0	0	False	12 31, 2030 11:59	false	<input checked="" type="checkbox"/>
	0909		0	1	0	True	12 31, 2030 11:59	false	<input type="checkbox"/>

 Refresh  Upload from the device



## Editing Device Settings and Information

You can edit detailed information of registered devices.

- 1 Double-click the device to edit. Or, Right-click on the device and click **Config Device**.
- 2 Edit the necessary fields of the INFORMATION, AUTHENTICATION, and NETWORK.

The screenshot shows a configuration window with three main sections:

- 1 INFORMATION:** Contains fields for Name (with a RENAME button), Device Type (Biostation 2), Device ID (546832506), and Firmware ver. (1.8.0(2019/08/06 02:37:57)).
- 2 AUTHENTICATION:** Contains radio button options for various authentication modes: Card or Biometrics, Biometric Only, Card Only, Biometric + PIN, Card + PIN or Biometric + PIN, Card + PIN or Biometric, Card or Biometric + PIN, Card + Biometric, Card + PIN, and Card + Biometric + PIN.
- 3 NETWORK:** Contains a checked checkbox for DHCP Use, and input fields for IP Address (192.168.14.221), Subnet Mask (255.255.255.0), Gateway (192.168.14.1), Device Port (51211), Direction (Server to Device), Server Address, and Server Port (51212). An APPLY button is at the bottom right.

No.	Item	Description
1	INFORMATION	<p>You can edit the name of the device or see the device information.</p> <ul style="list-style-type: none"> <li>• <b>Name:</b> Enter a device name.</li> <li>• <b>Device Type:</b> View the device type.</li> <li>• <b>Device ID:</b> View the device ID.</li> <li>• <b>Firmware ver.:</b> View the kernel version.</li> </ul>
2	AUTHENTICATION	<p>You can configure the authentication modes of the device.</p>
3	NETWORK	<p>You can configure the connection settings.</p> <ul style="list-style-type: none"> <li>• <b>DHCP:</b> Select this option to allow the device to use a dynamic IP address.</li> <li>• <b>IP Address:</b> Enter network settings of the device.</li> <li>• <b>Subnet Mask:</b> Enter network settings of the device.</li> <li>• <b>Gateway:</b> Enter network settings of the device.</li> <li>• <b>Device Port:</b> Enter a port to be used by the device.</li> <li>• <b>Direction:</b> Select the direction.</li> <li>• <b>Server Address:</b> Enter the IP address of the Suprema Integration with Paxton Net2 server.</li> <li>• <b>Server Port:</b> Enter the port number of the Suprema Integration with Paxton Net2 server.</li> </ul>

- 3 Click **APPLY** to save the settings.

## Resend Configuration

You can apply device settings configured in the **Settings** menu to devices.

### NOTE

- Make sure that **Global Device Configuration** is set up correctly before running **Resent Config**.

- 1 Click  to move to the **Devices** menu.
- 2 Click a device to apply settings and click **Resend Config**.  
If you click **Resend Config** with nothing selected, the settings are applied to all devices.

## Upgrade F/W

You can easily upgrade the firmware on any device connected to Suprema Integration with Paxton Net2 without any additional connection or action.

Copy the firmware files that you have downloaded to the following folder. If the folder does not exist, you need to create it.

- 1 Click  to move to the **Devices** menu.
- 2 Select a device and click **Upgrade F/W**.
- 3 Select the firmware file and click **Upgrade**.

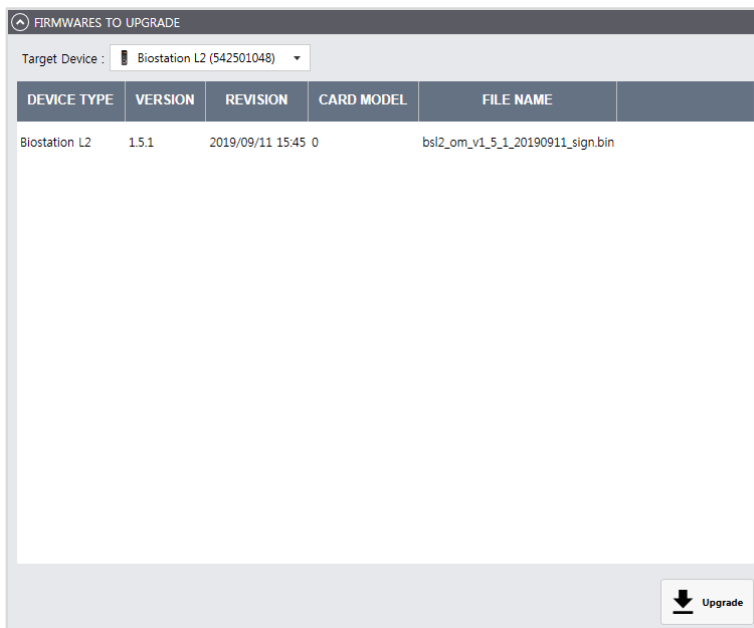

## Connect Device

You can reconnect the selected device from the Suprema Integration with Paxton Net2.

- 1 Click  to move to the **Devices** menu.
- 2 Select devices to reconnect and click **Connect**.

## Remove Device

You can delete the selected device from the list.

- 1 Click  to move to the **Devices** menu.
- 2 Select devices to delete and click **Remove**.

## Other Settings

You can reboot or reset to factory default by selecting individual devices. You can also edit other settings, such as a lock or unlock the device.

- 1 Click  to move to the **Devices** menu.
- 2 Right-click the device for which you want to edit the settings.
- 3 Select and set the item to edit.
  - **Rename:** You can change the device name.
  - **Resync:** Delete all user data in the device and send the user data of the server.
  - **Reboot:** You can restart the device.
  - **Here I am:** You can check the location of the device by making a sound on the selected device.
  - **Lock:** You can lock the device. When a device is locked, the user cannot authenticate on that device.
  - **Unlock:** You can unlock the device.
  - **All alarms off:** You can turn off all alarms on the device.
  - **Factory Reset:** You can delete all data and root certificate on the device and reset the settings. The network settings will not be reset.
  - **Delete All Users:** Delete all user data from the device.
  - **Device Config:** You can edit the device settings.

### NOTE

- You can set the LED status indicator on the Suprema devices to output the same color as other devices of the Net2 Access Control system for the access granted/denied events.

1. Click  **Start > All programs > Net2 Access Control > Net2 Configuration Utility**.

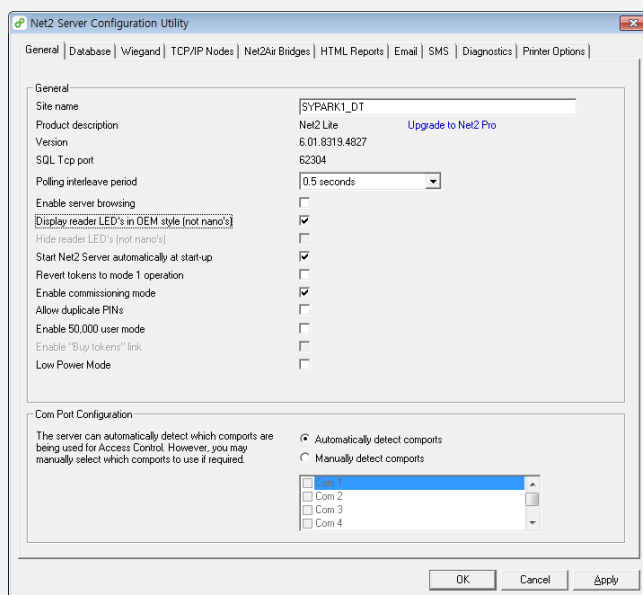

2. Click **General** tab > **Display reader LED's in OEM style (not nano's)**.
3. Click **Apply** to save the setting.

# Users

## Users Overview

The list of users registered in the Paxton Net2 Access Control system is automatically synchronized to Suprema Integration with Paxton Net2. Also, if the users are registered or deleted in the Paxton Net2 Access Control system, the revised list will be automatically synchronized in real-time to Suprema Integration with Paxton Net2. You can register various credentials by selecting a user from the **Users** menu in Suprema Integration with Paxton Net2.

ID	NAME	EXPIRED AT	LAST UPDATED AT
1	Simba Park	False	1 15, 2020 02:27 오후
2	Jacey Ryu	False	1 15, 2020 02:46 오후
3	9090	False	1 29, 2020 11:02 오전
4	9091	False	1 29, 2020 11:04 오전
5	9092	False	1 29, 2020 11:05 오전
6	9093	False	1 29, 2020 11:09 오전
1003	Chloe	False	5 14, 2020 11:35 오전

- **Search...:** You can search for users by entering the user name or ID.
- **Get All users from Net2:** You can manually import user data stored in the Net2 Access Control system.
- **Resend to All Devices:** You can send users to all devices connected to Suprema Integration with Paxton Net2.
- **Manage Cards:** You can select the card value to communicate with Net2 via Wiegand.
- **Manage Fingerprints:** You can add, edit, or delete a user's fingerprint template.
- **Manage Faces:** You can add, edit, or delete a user's face template.
- **Manage Pin:** You can add, edit, or delete a user's Pin.

## Select Card

When a user authenticates with a biometric credential on the device, Suprema Integration with Paxton Net2 sends that user's card ID to Paxton Net2 via Wiegand. Select the card you want to send to Net2.

- 1 Add users on the **Net2 Access Control** system.
- 2 Click  to move to the **Users** menu.
- 3 Select users and click **Manage Cards**.
- 4 Select the output card.

CARDS

Output Card

- 5 Click **APPLY** to save the settings.

## Enroll Pin

- 1 Add users on the **Net2 Access Control** system.
- 2 Click  to move to the **Users** menu.
- 3 Select users and click **Manage Pin**.
- 4 Enter a PIN to use.

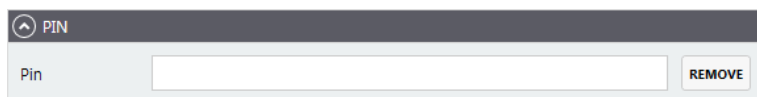

- 5 Click **APPLY** to save the settings.

## Enroll Fingerprint

In Suprema Integration with Paxton Net2 server, you can enroll user's fingerprints by selecting the device or USB fingerprint scanner. Or, you can also select the user on the device with an LCD display to enroll the fingerprint directly.

Whether you enroll the fingerprint on a server or on a specific device, that user's information is synchronized in real time on all devices connected to Suprema Integration with Paxton Net2.

### NOTE

- You can register up to 10 fingerprints per user.
- If the fingerprint authentication rate is low, delete the existing fingerprint information and add a new fingerprint.
- For best fingerprint scanning quality, make sure to cover the entire surface of the fingerprint sensor with the finger. We recommend using the index finger or the middle finger.

## Server

- 1 Add users on the **Net2 Access Control** system.
- 2 Click  to move to the **Users** menu.
- 3 Select a user and click **Manage Fingerprints**.
- 4 Configure the settings.

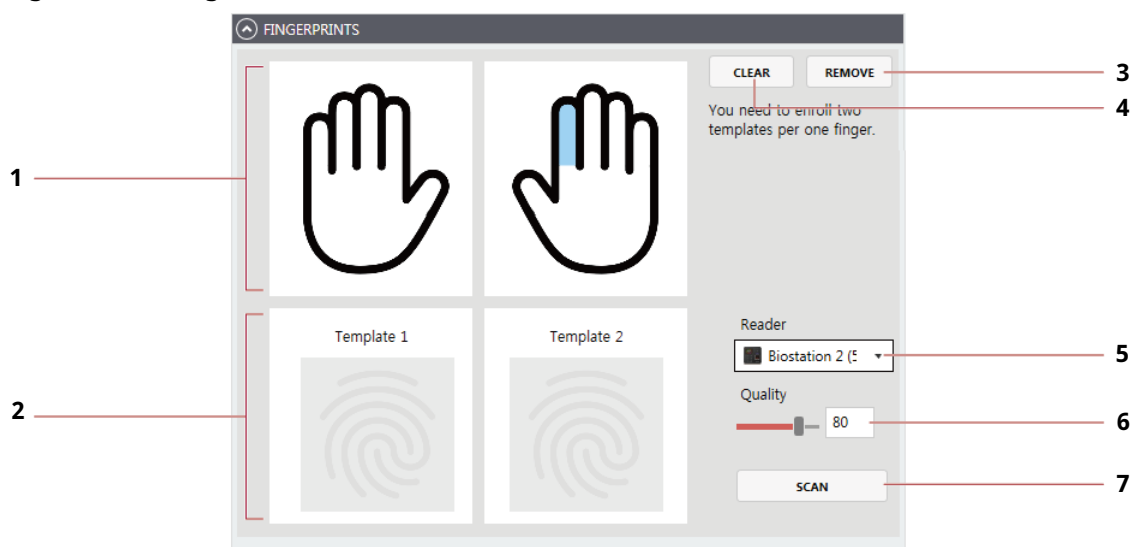

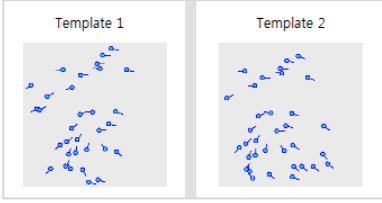

No.	Item	Description
1	Finger Selection	Select a finger from image to enroll a fingerprint.
2	Fingerprint Image	This section shows the analysis of the fingerprint enrolled. 
3	Remove	Delete a selected fingerprint template.
4	Clear	Delete all registered fingerprint templates.
5	Reader	Select a device or USB fingerprint scanner to enroll the fingerprint with. <b>NOTE</b> <ul style="list-style-type: none"> <li>Only devices connected to Suprema Integration with Paxton Net2 are displayed in the <b>Reader</b> list. Register the device first by referring to <a href="#">Search and Registration</a> and then enroll fingerprints.</li> </ul>
6	Quality	Select a fingerprint enrollment quality level. Any fingerprint which does not meet the quality requirement will not be enrolled.
7	Scan	Click <b>SCAN</b> and then place a finger on the fingerprint scanner or the device sensor.

**5** Click **APPLY** to enroll the fingerprint.

## Device

### NOTE

- This section uses the BioStation A2 as an example. The user interface such as the name of functions and the shape of icons may be different for each device.
- For how to register the fingerprint of each device, refer to the user guide of the device.

- Add users on the **Net2 Access Control** system.  
You can view the added user in the user list of the device connected to Suprema Integration with Paxton Net2.
- On the device, press  and authenticate with the Admin level credential.
- Press **User** and select a user to add a fingerprint.
- Press  and **Fingerprint**.
- Press  and enroll the fingerprint. Scan the fingerprint of a finger you wish to enroll, and then scan the fingerprint of the same finger again.

## Enroll Face

In Suprema Integration with Paxton Net2 server, you can enroll user's face by selecting the device. Or, you can also select the user on the device with an LCD display to enroll the face directly.

Whether you enroll the face on a server or on a specific device, that user's information is synchronized in real time on all devices connected to Suprema Integration with Paxton Net2.

### NOTE

- You can register up to 5 face templates per user.
- If the face authentication rate is low, delete the existing face information and add a new face.
- When registering a face, maintain a distance of 40cm to 80cm between the device and the face.
- Be careful not to change the facial expression. (smiling face, drawn face, wink, etc.)
- If you do not follow the instructions on the screen, the face registration may take longer or may fail.
- Be careful not to cover the eyes or eyebrows.
- Do not wear hats, masks, sunglasses or eyeglasses.
- Be careful not to display two faces on the screen. Register one person at a time.
- It is recommended for a user wearing glasses to register both faces with and without glasses.

### Server

- 1 Add users on the **Net2 Access Control** system.
- 2 Click  to move to the **Users** menu.
- 3 Select a user and click **Manage Faces**.
- 4 Configure the settings.

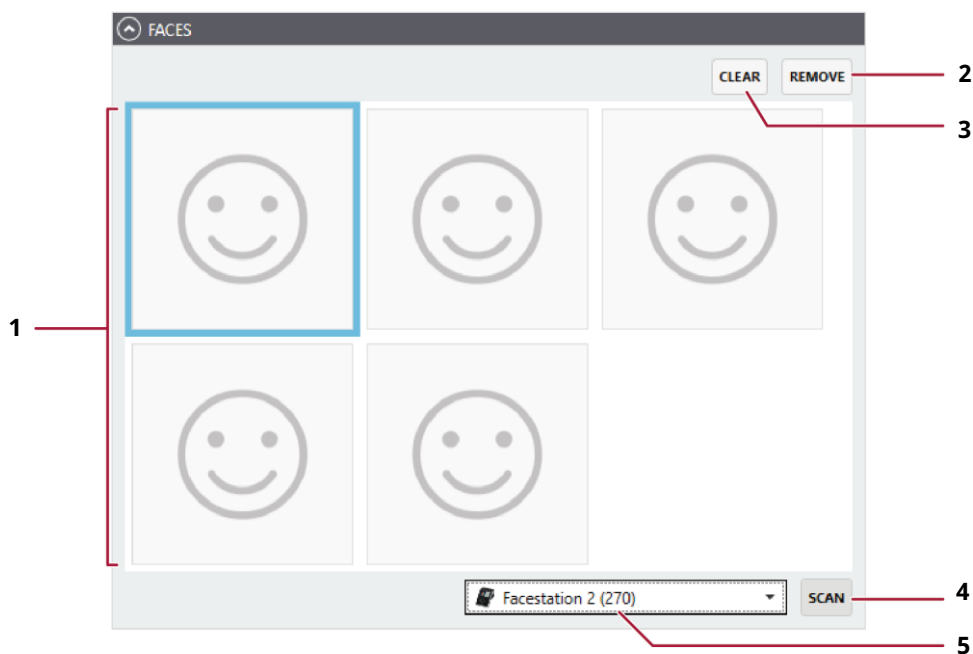

No.	Item	Description
1	Face Image	Select the face.
2	Remove	Delete the selected face template.
3	Clear	Delete all registered face templates.
4	Scan	Click <b>SCAN</b> and then follow the instructions on the device screen to scan.

5	Device	Select a device to enroll the face with.
---	--------	--

**5** Click **APPLY** to enroll the face.

## Device

### NOTE

- This section uses the FaceLite as an example. The user interface such as the name of functions and the shape of icons may be different for each device.
- For how to register the face of each device, refer to the user guide of the device.

- 1** Add users on the **Net2 Access Control** system.  
You can view the added user in the user list of the device connected to Suprema Integration with Paxton Net2.
- 2** Press **ESC** and authenticate with the Admin level credential.
- 3** Select **USER > Search User** and press **OK**.
- 4** Select a user to add a face.
- 5** Press **Edit > OK** and select **Face > OK**.
- 6** Press **+ Add Face > OK**.
- 7** Register a face according to the instructions on the screen.
- 8** Press **Apply** to enroll the face.

## Resend to All Devices

You can send users to all devices connected to Suprema Integration with Paxton Net2.

- 1** Add users on the **Net2 Access Control** system.
- 2** Click  to move to the **Users** menu.
- 3** Select users to send and click **Resend to All Devices**.
- 4** Check the list of users on the device.



# Monitoring

You can use the Monitoring menu to view lists of events that occurred on device.

- 1 Click  to move to the **Monitoring** menu.
- 2 Check the list of events.  
Click **Clear** to refresh the list of events.

Monitoring					
	DATETIME	EVENT	USER	DEVICE	INDEX
	2020-08-13 오후 4:28:08	1:N authentication succeeded (Fingerprint)	Camila (462)	Main Door BS2 (546832586)	3643
	2020-08-13 오후 4:27:57	User update succeeded	Camila (462)	Main Door BS2 (546832586)	3642
	2020-08-13 오후 4:27:57	User update succeeded	Camila (462)	Front Door FS2 (542191492)	2970
	2020-08-13 오후 4:27:53	User update succeeded	Camila (462)	Front Door FS2 (542191492)	2969
	2020-08-13 오후 4:27:54	User update succeeded	Camila (462)	Main Door BS2 (546832586)	3641
	2020-08-13 오후 4:25:44	User enrollment succeeded	Mason (463)	Main Door BS2 (546832586)	3640
	2020-08-13 오후 4:25:44	User enrollment succeeded	Mason (463)	Front Door FS2 (542191492)	2968
	2020-08-13 오후 4:25:35	User enrollment succeeded	Camila (462)	Main Door BS2 (546832586)	3639
	2020-08-13 오후 4:25:35	User enrollment succeeded	Camila (462)	Front Door FS2 (542191492)	2967
	2020-08-13 오후 4:25:24	User enrollment succeeded	Noah Lee (461)	Main Door BS2 (546832586)	3638
	2020-08-13 오후 4:25:24	User enrollment succeeded	Noah Lee (461)	Front Door FS2 (542191492)	2966
	2020-08-13 오후 4:25:16	User enrollment succeeded	James (460)	Main Door BS2 (546832586)	3637

 Clear

# Audit Trail

Audit trail tracks user access information as well as all the information changed in the system. You can set a filter for each item for sorting.

- 1 Click  to move to the **Audit Trail** menu.
- 2 Configure the filters.

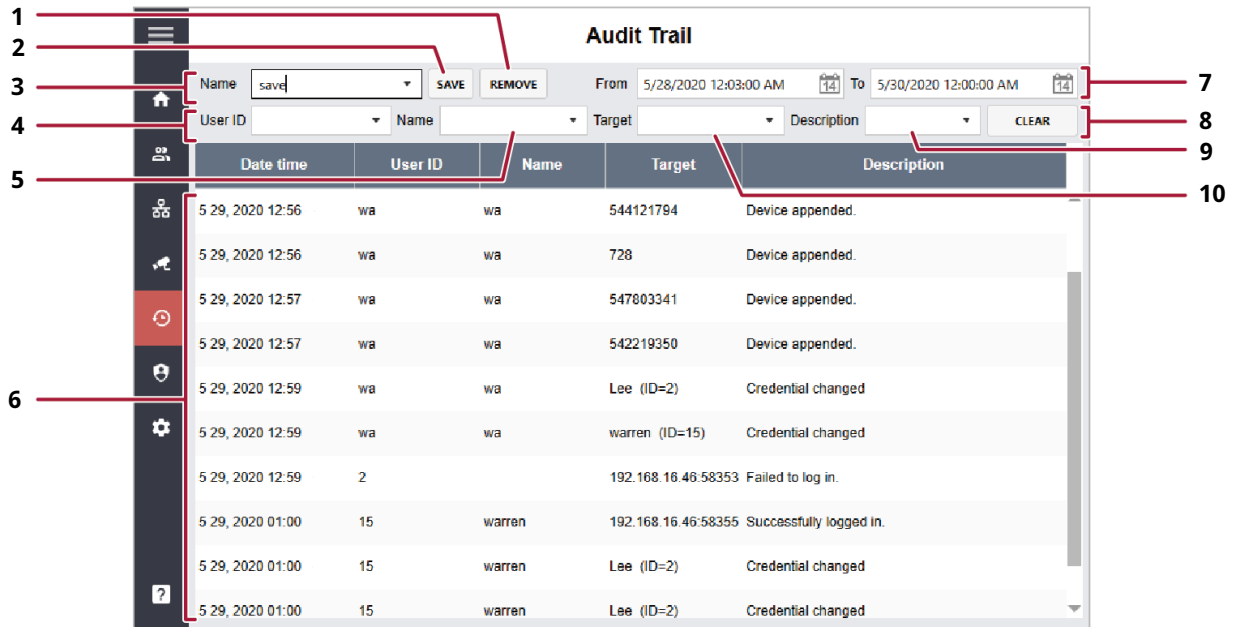

No.	Item	Description
1	REMOVE	You can remove the applied filter. Click <b>REMOVE</b> to remove the filter.
2	SAVE	You can set conditions for each filter item. Click <b>Save</b> to save the filter.
3	Name	If the filter is already saved, you can select the filter to sort the audit trail list.
4	User ID	You can select the user ID to sort the audit trail list.
5	Name	You can select the name to sort the audit trail list.
6	Audit List	Shows the audit list.
7	Period	You can set the period to sort the audit trail list.
8	CLEAR	You can clear the set filter.
9	Description	You can select the description to sort the audit trail list.
10	Target	You can select the target to sort the audit trail list.

# Accounts

You can assign administrator account levels to registered users.

- 1 Click  to move to the **Accounts** menu.
- 2 Configure the settings.

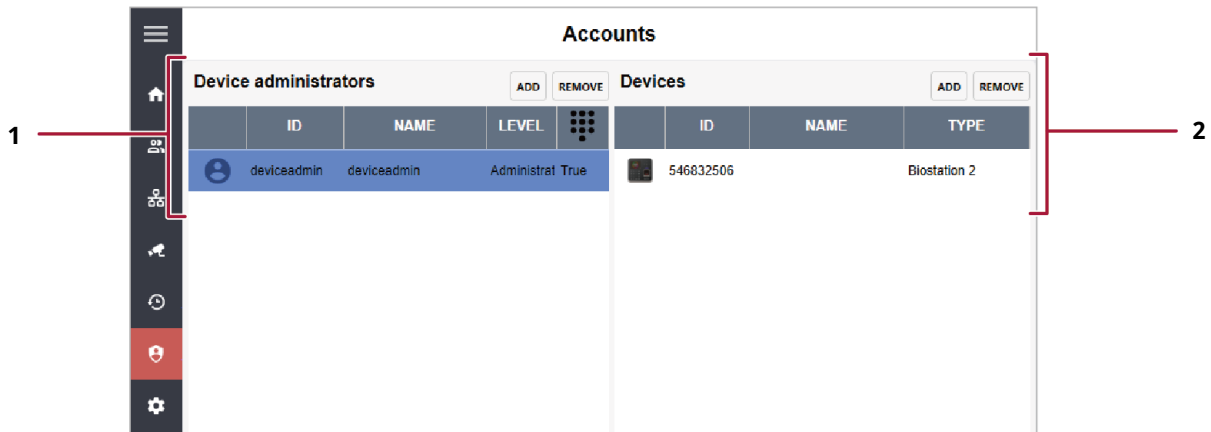

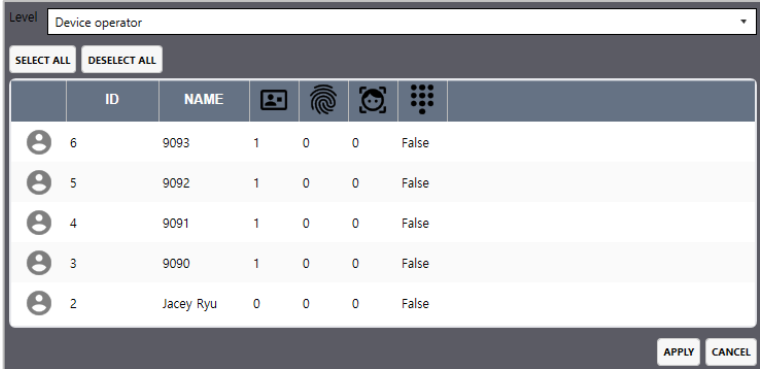
No.	Item	Description
1	Device administrators	<p>A list of administrators registered with Suprema Integration with Paxton Net2 is displayed. If the pin is set in the administrator account, the administrator can log in directly to Suprema Integration with Paxton Net2.</p> <ul style="list-style-type: none"> <li><b>ADD:</b> You can assign the administrator level by selecting a user. Select an account level type, then click on the user to whom you want to assign that level.</li> </ul>  <p>Click <b>APPLY</b> to save the settings.</p> <p><b>NOTE</b></p> <ul style="list-style-type: none"> <li>The administrator account levels are as follows: <ul style="list-style-type: none"> <li>- <b>Administrator:</b> Users can access and use all menus.</li> <li>- <b>Device Operator:</b> If a PIN is registered with the user, the user can log in to Suprema Integration with Paxton Net2. Also, users can register user accounts in the client system and configure device settings by accessing devices.</li> <li>- <b>User Operator:</b> If a PIN is registered with the user, the user can log in to Suprema Integration with Paxton Net2. Also, users can register user accounts in the client system and enroll users in devices.</li> </ul> </li> <li><b>REMOVE:</b> You can remove an administrator.</li> </ul>
2	Devices	<p>The list of devices that can be managed by the user selected in the Device administrator list is displayed.</p> <ul style="list-style-type: none"> <li><b>ADD:</b> You can add devices to the selected administrator.</li> </ul>

SELECT ALL		Deselect ALL					
	ID	NAME	TYPE	DIRECTION	IP	P	
	547832712		Facelite	Server To Device	192.168.14.240	512	

APPLY CANCEL

Click **APPLY** to save the settings.

- **REMOVE:** You can remove the device from the selected administrator.

# Settings

## Global Device Configuration

You can edit detailed setting of registered devices.

- 1 Click  to move to the **Settings** menu.
- 2 Configure the settings.

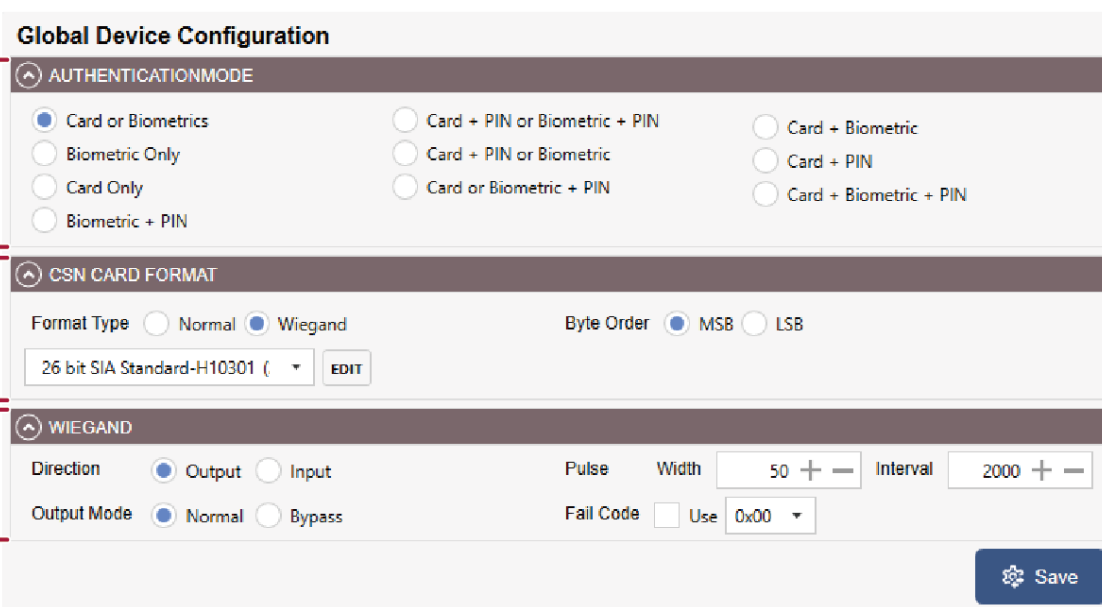

**Global Device Configuration**

**AUTHENTICATIONMODE**

Card or Biometrics
  Card + PIN or Biometric + PIN
  Card + Biometric  
 Biometric Only
  Card + PIN or Biometric
  Card + PIN  
 Card Only
  Card or Biometric + PIN
  Card + Biometric + PIN  
 Biometric + PIN

**CSN CARD FORMAT**

Format Type  Normal  Wiegand
 Byte Order  MSB  LSB  
 26 bit SIA Standard-H10301 (  )

**WIEGAND**

Direction  Output  Input
 Pulse Width  Interval   
 Output Mode  Normal  Bypass
 Fail Code  Use

No.	Item	Description
1	Authentication Mode	You can configure the authentication modes of the device. Suprema Integration with Paxton Net2 can use any combinations of biometric credentials, card, and PIN as authentication modes.
2	CSN Card Format	<p>You can set the CSN card format used by the device.</p> <ul style="list-style-type: none"> <li><b>Format Type:</b> If Format Type is set to <b>Normal</b>, the device will read the card serial number (CSN). If the option is set to <b>Wiegand</b>, the device will read the card serial number in a Wiegand format that the user has defined.</li> </ul> <p>If Format Type is set to <b>Wiegand</b>, you can set the Wiegand format to be used in the device. Click <b>EDIT</b> to edit the Wiegand format.</p> <p>You can configure the number of bits and rules for the Wiegand format directly in Suprema Integration with Paxton Net2, as in Net2 Access Control.</p> <ul style="list-style-type: none"> <li><b>Byte Order:</b> When Byte Order is set to <b>MSB</b>, the device reads a card ID from the highest byte to the lowest byte. When the option is set to <b>LSB</b>, the device reads a card ID from the lowest byte to the highest byte.</li> </ul>
3	Wiegand	<p>You can define the Wiegand Input/Output.</p> <ul style="list-style-type: none"> <li><b>Direction:</b> You can select input/output mode.</li> <li><b>Pulse Width:</b> You can set the pulse width of the Wiegand signal.</li> <li><b>Pulse Interval:</b> You can set the pulse interval of the Wiegand signal.</li> <li><b>Output Mode:</b> You can set the Wiegand signal output mode. If it is set to <b>Normal</b>, a card will be scanned in the set Wiegand format. If it is set to <b>Bypass</b>, CSN will be sent regardless of Wiegand authentication. <b>Bypass</b> should be set when using the device without an entrance door control function.</li> </ul> <p>If it is set to <b>Normal</b> mode, it is possible to set <b>Fail Code</b>, and select a value to be transmitted when Wiegand card authentication fails.</p>

- 3 Click **Save** to save the settings.

## Server Setting

You can set up the network for connecting with Net2 Access Control and devices. You can also activate the purchased license.

- 1 Click  to move to the **Settings** menu.
- 2 Configure the settings.

No.	Item	Description
1	Net2 Server	<ul style="list-style-type: none"> <li>• <b>Address:</b> Enter the IP address of the Net2 Access Control server.</li> <li>• <b>Port:</b> Enter the port number of the Net2 Access Control server.</li> <li>• <b>User ID:</b> Enter the operator ID of Suprema Integration with Paxton Net2.</li> <li>• <b>Password:</b> If you changed the password of the OEM Client in Net2 Access Control, click <b>CHANGE PASSWORD</b> to enter the changed password.</li> </ul>
2	Device Server	<ul style="list-style-type: none"> <li>• <b>Address:</b> Enter the IP address to be used by the device.</li> <li>• <b>Port:</b> Enter the port number to be used by the device.</li> </ul>
3	License	<ul style="list-style-type: none"> <li>• <b>User Name:</b> Enter the user name.</li> <li>• <b>Activation Key:</b> Enter the activation key that you've received from the Suprema local distributor.</li> </ul> <p><b>NOTE</b></p> <ul style="list-style-type: none"> <li>• To activate the license online, click <b>ACTIVATE</b> after entering your name and the activation key. To activate the license offline, click <b>REQUEST OFFLINE KEY</b>.</li> <li>• You can find contact details of your local distributor on the Suprema website (<a href="https://www.supremainc.com/en/wheretobuy/list.asp">https://www.supremainc.com/en/wheretobuy/list.asp</a>).</li> <li>• The valid date of the evaluation will be shown in <b>LICENSE</b>.</li> </ul>

- 3 Click **Save** to save the settings.

# Enrollment Helper Client

The Enrollment Helper provides an enrollment window for fingerprints and faces on the Net2 Access Control system. If you install the Enrollment Helper, you can enroll fingerprints and faces by opening a window for enrollment directly from the Net2 Access Control system.

## NOTE

- You can choose whether to install the Enrollment Helper when you install the Suprema Integration with Paxton Net 2.

## Enroll Credentials with Enrollment Helper

You can enroll fingerprints and faces for both existing and new users.

### Enroll Credentials to Existing User

- Run **Net2 Access Control**.
- Click **Users** menu and select the user to enroll fingerprints or faces on the user list.
- Click **Tokens** and then click **Add fingerprints**.

The screenshot shows the 'Tokens' tab for a user named Jacey Ryu. The user's details are: First name: Jacey, Surname: Ryu, Department: (none), Telephone: (empty), Personnel number: (empty). The 'Valid from' date is 2020-01-15, and the 'Expires end' is set to 'Never expires'. The 'Access rights' are set to 'PIN', and the 'Card template' is 'None'. The 'Add fingerprints' button is highlighted in the 'Tokens' list on the right.

- Click **Login** after entering the User ID and PIN.

The screenshot shows a 'Login' dialog box with the title 'Login'. It contains the text 'Input your ID and PIN' and two input fields: 'User ID' and 'PIN'. At the bottom, there are three buttons: 'Setting', 'Login', and 'Cancel'.

**NOTE**

- A user can login with an account that has the administrator permission for Suprema Integration with Paxton Net2.
- Click **Setting** to change the host Address and port. And you can also choose whether to save tokens automatically. If you select **Save the token automatically** option, the automatically generated token will be registered in the Paxton Net2 system.

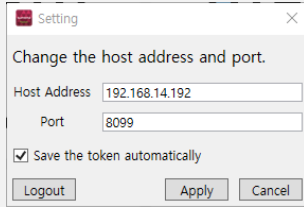

**5** Enroll fingerprints by referring to **Enroll Fingerprint**. Or, Enroll faces by referring to **Enroll Face**.



**NOTE**

- The user name and the value of the automatically generated token are displayed on the enrollment window.

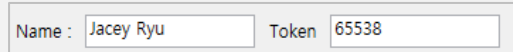

Token values can be changed, but we recommend that you use auto-generated values to prevent duplicate values from being generated.

**6** Click **Add user** to save the settings. The token generated for the credential is displayed on the Tokens tab.

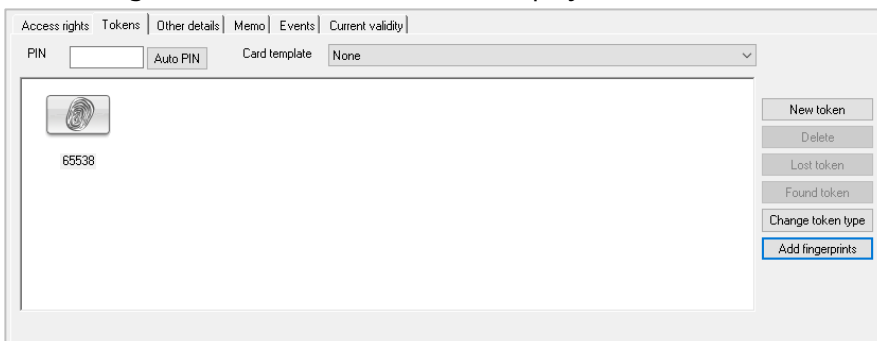



## Enroll Credentials to New User

- 1 Run **Net2 Access Control**.
- 2 Click **Users** menu and double-click **+New user**.
- 3 Enter the user information to add and click **Add fingerprints**.

- 4 Click **Login** after entering the User ID and PIN.

### NOTE

- A user can login with an account that has the administrator permission for Suprema Integration with Paxton Net2.
- Click **Setting** to change the host Address and port. And you can also choose whether to save tokens automatically. If you select **Save the token automatically** option, the automatically generated token will be registered in the Paxton Net2 system.

**5** Enroll fingerprints by referring to **Enroll Fingerprint**. Or, Enroll faces by referring to **Enroll Face**.



**NOTE**

- The user name and the value of the automatically generated token are displayed on the enrollment window.

Name :  Token

Token values can be changed, but we recommend that you use auto-generated values to prevent duplicate values from being generated.

**6** Click **Add user** to save the settings.

The token generated for the credential is displayed on the Tokens tab.

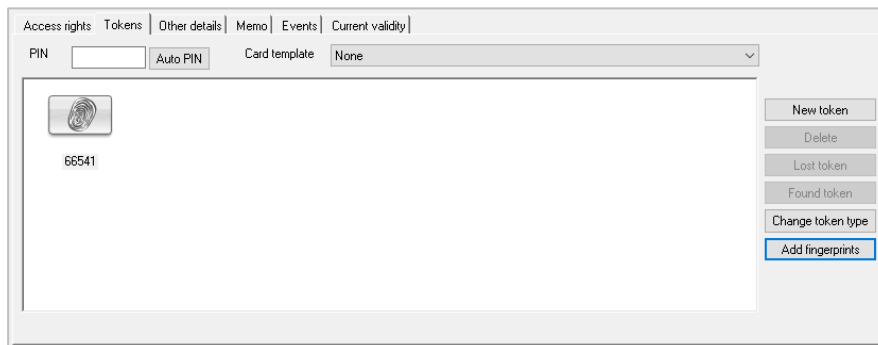

# Appendices

## Disclaimers

- The information contained in this Guide is provided in regard to the Suprema product.
- Your right of usage is recognized only for products included in sales agreements and conditions guaranteed by Suprema. No license rights over other intellectual properties mentioned in this Guide are recognized.
- Suprema makes no representations or warranties concerning infringement of patents, copyrights or other intellectual property rights as well as merchantability and fitness of the product for a particular purpose in regard to the sale or use of the Suprema product.
- Do not use the Suprema product in medical, life-saving and life-sustaining situations or in situations where malfunction of the product could lead to personal injury or loss of life. However, if an accident occurs while the purchaser is using the product in any of the situations stated above, even if shortcomings are discovered in the design or production process of the product and are claimed as a point of major negligence, employees, subsidiaries, branches, affiliates, or distributors of Suprema shall not be liable and shall not make reimbursements for any direct or indirect costs or expenses associated, including lawyer fees.
- Suprema may change the product standards and specifications at any time without any adequate notice for improvements in stability, performance or design of the product. Designers should keep in mind that features or descriptions marked as 'to be implemented' or 'to be defined' are always subject to change. Suprema will implement or define such features or descriptions in a near future and shall not be liable for any consequent problems, including problems of compatibility.
- If you wish to obtain the latest specification documentation before you place an order for the product, please contact Suprema, a sales agent of Suprema or a regional distributor.

## Copyright Notice

The copyright of this document is vested in Suprema. The rights of other product names, trademarks and registered trademarks are vested in each individual or organization that owns such rights.

## Open Source License

### gin-gonic/gin

The MIT License (MIT)

Copyright (c) 2014 Manuel Martínez-Almeida

Permission is hereby granted, free of charge, to any person obtaining a copy of this software and associated documentation files (the "Software"), to deal in the Software without restriction, including without limitation the rights to use, copy, modify, merge, publish, distribute, sublicense, and/or sell copies of the Software, and to permit persons to whom the Software is furnished to do so, subject to the following conditions:

The above copyright notice and this permission notice shall be included in all copies or substantial portions of the Software.

THE SOFTWARE IS PROVIDED "AS IS", WITHOUT WARRANTY OF ANY KIND, EXPRESS OR IMPLIED, INCLUDING BUT NOT LIMITED TO THE WARRANTIES OF MERCHANTABILITY, FITNESS FOR A PARTICULAR PURPOSE AND NONINFRINGEMENT. IN NO EVENT SHALL THE AUTHORS OR COPYRIGHT HOLDERS BE LIABLE FOR ANY CLAIM, DAMAGES OR OTHER LIABILITY, WHETHER IN AN ACTION OF CONTRACT, TORT OR OTHERWISE, ARISING FROM,

OUT OF OR IN CONNECTION WITH THE SOFTWARE OR THE USE OR OTHER DEALINGS IN THE SOFTWARE.

### **Gorm**

The MIT License (MIT)  
Copyright (c) 2013-NOW Jinzhu <wosmvp@gmail.com>

Permission is hereby granted, free of charge, to any person obtaining a copy of this software and associated documentation files (the "Software"), to deal in the Software without restriction, including without limitation the rights to use, copy, modify, merge, publish, distribute, sublicense, and/or sell copies of the Software, and to permit persons to whom the Software is furnished to do so, subject to the following conditions:

The above copyright notice and this permission notice shall be included in all copies or substantial portions of the Software.

THE SOFTWARE IS PROVIDED "AS IS", WITHOUT WARRANTY OF ANY KIND, EXPRESS OR IMPLIED, INCLUDING BUT NOT LIMITED TO THE WARRANTIES OF MERCHANTABILITY, FITNESS FOR A PARTICULAR PURPOSE AND NONINFRINGEMENT. IN NO EVENT SHALL THE AUTHORS OR COPYRIGHT HOLDERS BE LIABLE FOR ANY CLAIM, DAMAGES OR OTHER LIABILITY, WHETHER IN AN ACTION OF CONTRACT, TORT OR OTHERWISE, ARISING FROM, OUT OF OR IN CONNECTION WITH THE SOFTWARE OR THE USE OR OTHER DEALINGS IN THE SOFTWARE.

### **Go-ps**

The MIT License (MIT)  
Copyright (c) 2014 Mitchell Hashimoto

Permission is hereby granted, free of charge, to any person obtaining a copy of this software and associated documentation files (the "Software"), to deal in the Software without restriction, including without limitation the rights to use, copy, modify, merge, publish, distribute, sublicense, and/or sell copies of the Software, and to permit persons to whom the Software is furnished to do so, subject to the following conditions:

The above copyright notice and this permission notice shall be included in all copies or substantial portions of the Software.

THE SOFTWARE IS PROVIDED "AS IS", WITHOUT WARRANTY OF ANY KIND, EXPRESS OR IMPLIED, INCLUDING BUT NOT LIMITED TO THE WARRANTIES OF MERCHANTABILITY, FITNESS FOR A PARTICULAR PURPOSE AND NONINFRINGEMENT. IN NO EVENT SHALL THE AUTHORS OR COPYRIGHT HOLDERS BE LIABLE FOR ANY CLAIM, DAMAGES OR OTHER LIABILITY, WHETHER IN AN ACTION OF CONTRACT, TORT OR OTHERWISE, ARISING FROM, OUT OF OR IN CONNECTION WITH THE SOFTWARE OR THE USE OR OTHER DEALINGS IN THE SOFTWARE.

### **google/uuid**

Copyright (c) 2009,2014 Google Inc. All rights reserved.

Redistribution and use in source and binary forms, with or without modification, are permitted provided that the following conditions are met:

- \* Redistributions of source code must retain the above copyright notice, this list of conditions and the following disclaimer.
- \* Redistributions in binary form must reproduce the above copyright notice, this list of conditions and the following disclaimer in the documentation and/or other materials provided with the distribution.
- \* Neither the name of Google Inc. nor the names of its contributors may be used to endorse or promote products derived from this software without specific prior written permission.

THIS SOFTWARE IS PROVIDED BY THE COPYRIGHT HOLDERS AND CONTRIBUTORS "AS IS" AND ANY EXPRESS OR IMPLIED WARRANTIES, INCLUDING, BUT NOT LIMITED TO, THE IMPLIED WARRANTIES OF MERCHANTABILITY AND FITNESS FOR A PARTICULAR PURPOSE ARE DISCLAIMED. IN NO EVENT SHALL THE COPYRIGHT OWNER OR CONTRIBUTORS BE LIABLE FOR ANY DIRECT, INDIRECT, INCIDENTAL, SPECIAL, EXEMPLARY, OR CONSEQUENTIAL DAMAGES (INCLUDING, BUT NOT LIMITED TO, PROCUREMENT OF SUBSTITUTE GOODS OR SERVICES; LOSS OF USE, DATA, OR PROFITS; OR BUSINESS INTERRUPTION) HOWEVER CAUSED AND ON ANY THEORY OF LIABILITY, WHETHER IN CONTRACT, STRICT LIABILITY, OR TORT (INCLUDING NEGLIGENCE OR OTHERWISE) ARISING IN ANY WAY OUT OF THE USE OF THIS SOFTWARE, EVEN IF ADVISED OF THE POSSIBILITY OF SUCH DAMAGE.

### **gorilla/websocket**

Copyright (c) 2013 The Gorilla WebSocket Authors. All rights reserved.

Redistribution and use in source and binary forms, with or without modification, are permitted provided that the following conditions are met:

Redistributions of source code must retain the above copyright notice, this list of conditions and the following disclaimer.

Redistributions in binary form must reproduce the above copyright notice, this list of conditions and the following disclaimer in the documentation and/or other materials provided with the distribution.

THIS SOFTWARE IS PROVIDED BY THE COPYRIGHT HOLDERS AND CONTRIBUTORS "AS IS" AND ANY EXPRESS OR IMPLIED WARRANTIES, INCLUDING, BUT NOT LIMITED TO, THE IMPLIED WARRANTIES OF MERCHANTABILITY AND FITNESS FOR A PARTICULAR PURPOSE ARE DISCLAIMED. IN NO EVENT SHALL THE COPYRIGHT HOLDER OR CONTRIBUTORS BE LIABLE FOR ANY DIRECT, INDIRECT, INCIDENTAL, SPECIAL, EXEMPLARY, OR CONSEQUENTIAL DAMAGES (INCLUDING, BUT NOT LIMITED TO, PROCUREMENT OF SUBSTITUTE GOODS OR SERVICES; LOSS OF USE, DATA, OR PROFITS; OR BUSINESS INTERRUPTION) HOWEVER CAUSED AND ON ANY THEORY OF LIABILITY, WHETHER IN CONTRACT, STRICT LIABILITY, OR TORT (INCLUDING NEGLIGENCE OR OTHERWISE) ARISING IN ANY WAY OUT OF THE USE OF THIS SOFTWARE, EVEN IF ADVISED OF THE POSSIBILITY OF SUCH DAMAGE.

### **CommandLineParser**

The MIT License (MIT)

Copyright (c) 2005 - 2015 Giacomo Stelluti Scala & Contributors

Permission is hereby granted, free of charge, to any person obtaining a copy of this software and associated documentation files (the "Software"), to deal in the Software without restriction, including without limitation the rights to use, copy, modify, merge, publish, distribute, sublicense, and/or sell copies of the Software, and to permit persons to whom the Software is furnished to do so, subject to the following conditions:

The above copyright notice and this permission notice shall be included in all copies or substantial portions of the Software.

THE SOFTWARE IS PROVIDED "AS IS", WITHOUT WARRANTY OF ANY KIND, EXPRESS OR IMPLIED, INCLUDING BUT NOT LIMITED TO THE WARRANTIES OF MERCHANTABILITY, FITNESS FOR A PARTICULAR PURPOSE AND NONINFRINGEMENT. IN NO EVENT SHALL THE AUTHORS OR COPYRIGHT HOLDERS BE LIABLE FOR ANY CLAIM, DAMAGES OR OTHER LIABILITY, WHETHER IN AN ACTION OF CONTRACT, TORT OR OTHERWISE, ARISING FROM, OUT OF OR IN CONNECTION WITH THE SOFTWARE OR THE USE OR OTHER DEALINGS IN THE SOFTWARE.

## **MahApps Metro**

MIT License

Copyright (c) 2011-2016 MahApps

Permission is hereby granted, free of charge, to any person obtaining a copy of this software and associated documentation files (the "Software"), to deal in the Software without restriction, including without limitation the rights to use, copy, modify, merge, publish, distribute, sublicense, and/or sell copies of the Software, and to permit persons to whom the Software is furnished to do so, subject to the following conditions:

The above copyright notice and this permission notice shall be included in all copies or substantial portions of the Software.

THE SOFTWARE IS PROVIDED "AS IS", WITHOUT WARRANTY OF ANY KIND, EXPRESS OR IMPLIED, INCLUDING BUT NOT LIMITED TO THE WARRANTIES OF MERCHANTABILITY, FITNESS FOR A PARTICULAR PURPOSE AND NONINFRINGEMENT. IN NO EVENT SHALL THE AUTHORS OR COPYRIGHT HOLDERS BE LIABLE FOR ANY CLAIM, DAMAGES OR OTHER LIABILITY, WHETHER IN AN ACTION OF CONTRACT, TORT OR OTHERWISE, ARISING FROM, OUT OF OR IN CONNECTION WITH THE SOFTWARE OR THE USE OR OTHER DEALINGS IN THE SOFTWARE.

## **MahApps Metro IconPacks**

The MIT License (MIT)

Copyright (c) 2016-2019 MahApps, Jan Karger

Permission is hereby granted, free of charge, to any person obtaining a copy of this software and associated documentation files (the "Software"), to deal in the Software without restriction, including without limitation the rights to use, copy, modify, merge, publish, distribute, sublicense, and/or sell copies of the Software, and to permit persons to whom the Software is furnished to do so, subject to the following conditions:

The above copyright notice and this permission notice shall be included in all copies or substantial portions of the Software.

THE SOFTWARE IS PROVIDED "AS IS", WITHOUT WARRANTY OF ANY KIND, EXPRESS OR IMPLIED, INCLUDING BUT NOT LIMITED TO THE WARRANTIES OF MERCHANTABILITY, FITNESS FOR A PARTICULAR PURPOSE AND NONINFRINGEMENT. IN NO EVENT SHALL THE AUTHORS OR COPYRIGHT HOLDERS BE LIABLE FOR ANY CLAIM, DAMAGES OR OTHER LIABILITY, WHETHER IN AN ACTION OF CONTRACT, TORT OR OTHERWISE, ARISING FROM, OUT OF OR IN CONNECTION WITH THE SOFTWARE OR THE USE OR OTHER DEALINGS IN THE SOFTWARE.

## **Newtonsoft.Json**

The MIT License (MIT)

Copyright (c) 2007 James Newton-King

Permission is hereby granted, free of charge, to any person obtaining a copy of this software and associated documentation files (the "Software"), to deal in the Software without restriction, including without limitation the rights to use, copy, modify, merge, publish, distribute, sublicense, and/or sell copies of the Software, and to permit persons to whom the Software is furnished to do so, subject to the following conditions:

The above copyright notice and this permission notice shall be included in all copies or substantial portions of the Software.

THE SOFTWARE IS PROVIDED "AS IS", WITHOUT WARRANTY OF ANY KIND, EXPRESS OR IMPLIED, INCLUDING BUT NOT LIMITED TO THE WARRANTIES OF MERCHANTABILITY, FITNESS FOR A PARTICULAR PURPOSE AND NONINFRINGEMENT. IN NO EVENT SHALL THE AUTHORS OR COPYRIGHT HOLDERS BE LIABLE FOR ANY CLAIM, DAMAGES OR OTHER LIABILITY, WHETHER IN AN ACTION OF CONTRACT, TORT OR OTHERWISE, ARISING FROM, OUT OF OR IN CONNECTION WITH THE SOFTWARE OR THE USE OR OTHER DEALINGS IN THE SOFTWARE.

## **Aphache/log4net**

Apache License

Version 2.0, January 2004

<http://www.apache.org/licenses/>

### TERMS AND CONDITIONS FOR USE, REPRODUCTION, AND DISTRIBUTION

#### 1. Definitions.

"License" shall mean the terms and conditions for use, reproduction, and distribution as defined by Sections 1 through 9 of this document.

"Licensor" shall mean the copyright owner or entity authorized by the copyright owner that is granting the License.

"Legal Entity" shall mean the union of the acting entity and all other entities that control, are controlled by, or are under common control with that entity. For the purposes of this definition, "control" means (i) the power, direct or indirect, to cause the direction or management of such entity, whether by contract or otherwise, or (ii) ownership of fifty percent (50%) or more of the outstanding shares, or (iii) beneficial ownership of such entity.

"You" (or "Your") shall mean an individual or Legal Entity exercising permissions granted by this License.

"Source" form shall mean the preferred form for making modifications, including but not limited to software source code, documentation source, and configuration files.

"Object" form shall mean any form resulting from mechanical transformation or translation of a Source form, including but not limited to compiled object code, generated documentation, and conversions to other media types.

"Work" shall mean the work of authorship, whether in Source or Object form, made available under the License, as indicated by a copyright notice that is included in or attached to the work (an example is provided in the Appendix below).

"Derivative Works" shall mean any work, whether in Source or Object form, that is based on (or derived from) the Work and for which the editorial revisions, annotations, elaborations, or other modifications represent, as a whole, an original work of authorship. For the purposes of this License, Derivative Works shall not include works that remain separable from, or merely link (or bind by name) to the interfaces of, the Work and Derivative Works thereof.

"Contribution" shall mean any work of authorship, including the original version of the Work and any modifications or additions to that Work or Derivative Works thereof, that is intentionally submitted to Licensor for inclusion in the Work by the copyright owner or by an individual or Legal Entity authorized to submit on behalf of the copyright owner. For the purposes of this definition, "submitted" means any form of electronic, verbal, or written communication sent to the Licensor or its representatives, including but not limited to

communication on electronic mailing lists, source code control systems, and issue tracking systems that are managed by, or on behalf of, the Licensor for the purpose of discussing and improving the Work, but excluding communication that is conspicuously marked or otherwise designated in writing by the copyright owner as "Not a Contribution."

"Contributor" shall mean Licensor and any individual or Legal Entity on behalf of whom a Contribution has been received by Licensor and subsequently incorporated within the Work.

2. Grant of Copyright License. Subject to the terms and conditions of this License, each Contributor hereby grants to You a perpetual, worldwide, non-exclusive, no-charge, royalty-free, irrevocable copyright license to reproduce, prepare Derivative Works of, publicly display, publicly perform, sublicense, and distribute the Work and such Derivative Works in Source or Object form.

3. Grant of Patent License. Subject to the terms and conditions of this License, each Contributor hereby grants to You a perpetual, worldwide, non-exclusive, no-charge, royalty-free, irrevocable (except as stated in this section) patent license to make, have made, use, offer to sell, sell, import, and otherwise transfer the Work, where such license applies only to those patent claims licensable by such Contributor that are necessarily infringed by their Contribution(s) alone or by combination of their Contribution(s) with the Work to which such Contribution(s) was submitted. If You institute patent litigation against any entity (including a cross-claim or counterclaim in a lawsuit) alleging that the Work or a Contribution incorporated within the Work constitutes direct or contributory patent infringement, then any patent licenses granted to You under this License for that Work shall terminate as of the date such litigation is filed.

4. Redistribution. You may reproduce and distribute copies of the Work or Derivative Works thereof in any medium, with or without modifications, and in Source or Object form, provided that You meet the following conditions:

(a) You must give any other recipients of the Work or Derivative Works a copy of this License; and

(b) You must cause any modified files to carry prominent notices stating that You changed the files; and

(c) You must retain, in the Source form of any Derivative Works that You distribute, all copyright, patent, trademark, and attribution notices from the Source form of the Work, excluding those notices that do not pertain to any part of the Derivative Works; and

(d) If the Work includes a "NOTICE" text file as part of its distribution, then any Derivative Works that You distribute must include a readable copy of the attribution notices contained within such NOTICE file, excluding those notices that do not pertain to any part of the Derivative Works, in at least one of the following places: within a NOTICE text file distributed as part of the Derivative Works; within the Source form or documentation, if provided along with the Derivative Works; or, within a display generated by the Derivative Works, if and wherever such third-party notices normally appear. The contents of the NOTICE file are for informational purposes only and do not modify the License. You may add Your own attribution notices within Derivative Works that You distribute, alongside or as an addendum to the NOTICE text from the Work, provided that such additional attribution notices cannot be construed as modifying the License.

You may add Your own copyright statement to Your modifications and may provide additional or different license terms and conditions for use, reproduction, or distribution of Your modifications, or for any such Derivative Works as a whole, provided Your use, reproduction, and distribution of the Work otherwise complies with the conditions stated in this License.

5. Submission of Contributions. Unless You explicitly state otherwise, any Contribution intentionally submitted for inclusion in the Work by You to the Licensor shall be under the terms and conditions of this License, without any additional terms or conditions. Notwithstanding the above, nothing herein shall supersede or modify the



terms of any separate license agreement you may have executed with Licensor regarding such Contributions.

6. Trademarks. This License does not grant permission to use the trade names, trademarks, service marks, or product names of the Licensor, except as required for reasonable and customary use in describing the origin of the Work and reproducing the content of the NOTICE file.

7. Disclaimer of Warranty. Unless required by applicable law or agreed to in writing, Licensor provides the Work (and each Contributor provides its Contributions) on an "AS IS" BASIS, WITHOUT WARRANTIES OR CONDITIONS OF ANY KIND, either express or implied, including, without limitation, any warranties or conditions of TITLE, NON-INFRINGEMENT, MERCHANTABILITY, or FITNESS FOR A PARTICULAR PURPOSE. You are solely responsible for determining the appropriateness of using or redistributing the Work and assume any risks associated with Your exercise of permissions under this License.

8. Limitation of Liability. In no event and under no legal theory, whether in tort (including negligence), contract, or otherwise, unless required by applicable law (such as deliberate and grossly negligent acts) or agreed to in writing, shall any Contributor be liable to You for damages, including any direct, indirect, special, incidental, or consequential damages of any character arising as a result of this License or out of the use or inability to use the Work (including but not limited to damages for loss of goodwill, work stoppage, computer failure or malfunction, or any and all other commercial damages or losses), even if such Contributor has been advised of the possibility of such damages.

9. Accepting Warranty or Additional Liability. While redistributing the Work or Derivative Works thereof, You may choose to offer, and charge a fee for, acceptance of support, warranty, indemnity, or other liability obligations and/or rights consistent with this License. However, in accepting such obligations, You may act only on Your own behalf and on Your sole responsibility, not on behalf of any other Contributor, and only if You agree to indemnify, defend, and hold each Contributor harmless for any liability incurred by, or claims asserted against, such Contributor by reason of your accepting any such warranty or additional liability.

END OF TERMS AND CONDITIONS

The logo for Suprema, featuring the word "suprema" in a bold, lowercase, sans-serif font. Below it, the words "SECURITY & BIOMETRICS" are written in a smaller, uppercase, sans-serif font. The entire logo is contained within a dark red rectangular box.

**suprema**  
SECURITY & BIOMETRICS

**Suprema Inc.**

17F Parkview Tower, 248, Jeongjail-ro, Bundang- gu, Seongnam-si, Gyeonggi-do, 13554, Rep. of KOREA

Tel: +82 31 783 4502 | Fax: +82 31 783 4503 | Inquiry: [sales\\_sys@supremainc.com](mailto:sales_sys@supremainc.com)

©2020 Suprema Inc. Suprema and identifying product names and numbers herein are registered trade marks of Suprema, Inc. All non-Suprema brands and product names are trademarks or registered trademarks of their respective companies. Product appearance, build status and/or specifications are subject to change without notice.